



2021 CATALOGUE

CONTENT INDEX

04	MGL GROUP	
	WHO IS MGL.....	04
	OUR BRANDS.....	04

06	MEASURING INSTRUMENTS	
	MULTIMETERS.....	08
	CLAMP METERS.....	16
	VOLTAGE TESTERS & TESTERS	21
	ENVIRONMENTAL TESTERS.....	26
	WIRE TESTERS	30
	INDUSTRIAL TESTERS.....	33
BUNDLES	35	

44	ENERGY SAVING	
	MOVEMENT DETECTORS	46
	SENSOR LIGHTS	58
	LIGHT CONTROLS.....	63
	DOORCHIMES	69
	SECURITY DETECTORS	74
	THERMOSTAS & CHRONOTHERMOSTATS ...	83
	TIMER SWITCHES	87
USB PLUGS.....	90	

92	INSTALLATION	
	FISH TAPES	94
	FISH TAPES REEL.....	97
	LUBRICANT FOR CABLE GUIDES	100
	INSULATING GEL	101

WHO IS MGL

We are a global group of companies operating locally. We manufacture test and measurement products for the electrical and automotive industry, from the entry level through high tech products.

Our companies work globally, serving our customers worldwide. This global network delivers a deeper understanding of each individual market, with solutions tailored to the unique requirements of each customer.

With customers over 20 years old, our goal is to be a recognized, honest and fair company. We aim to be the most valued partner for our customers in the research, development, manufacture and supply of innovative, modern and customer-focused technologies.

We have a highly experienced team which is openminded, receptive to new ideas and adaptive to evolving market trends. This solid foundation guarantees that we are well informed and fully equipped to deliver excellent solutions to meet our customers' real needs.



OUR BRANDS

We manufacture electrical test and measurement instruments under our own brands: Mastech, KPS, C-Logic and Power Probe, recognized brands and market leaders in the fields of electrical measurement and automotive. All of our products have a professional positioning based on advanced balanced technology and they are marketed through local distributors throughout the world.

We maintain direct and close contact with our distributors, through our offices around the world, and we support them in their business by offering technical advice and an after-sales service for our products.

MASTECH®

 **KPS®**

C-LOGIC®

POWER PROBE®

MGL AT A GLANCE



More than 800 employees



Annual production of +10 million units per year



Three factories in Taiwan, China and Europe



We manufacture more than 95% of our products, even the accessories

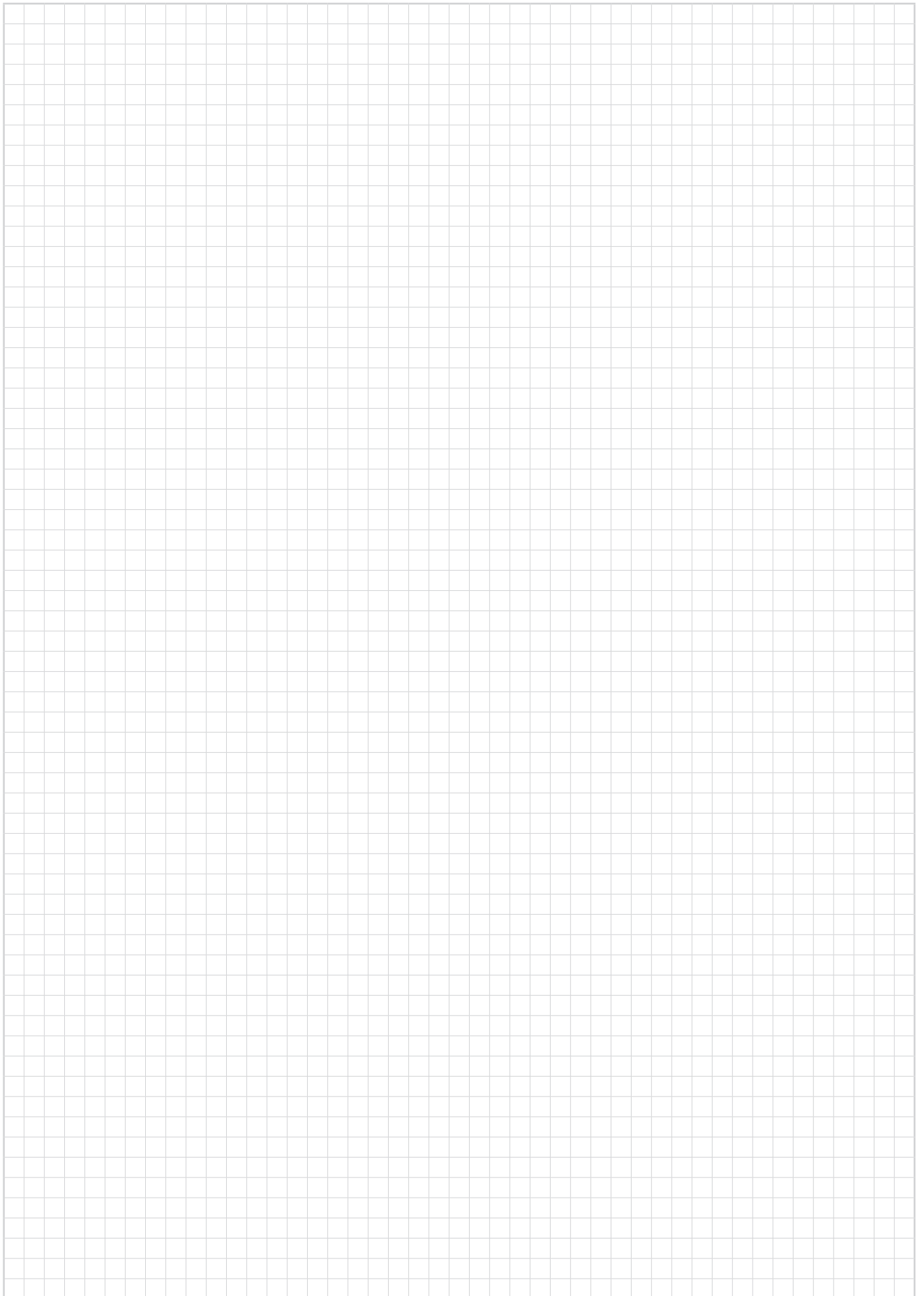



MEASURING INSTRUMENTS

- MULTIMETERS
- CLAMP METERS
- VOLTAGE TESTERS
- ENVIRONMENTAL TESTERS
- WIRE TESTERS
- INDUSTRIAL TESTERS
- BUNDLES

SYMBOL	DESCRIPTION
	CONTENTS
	Instructions
	1.5V AAA battery
	9V 6F22 battery
	12V A23S battery
	Test probes
	Test probes
	K-type thermocouple
	Multifunction socket
	Carrying bag
	Alligator clips
	RS232 connection (Serial port)
	Hard case
	USB charger
	CD box
	Earth rod
	Reflective sheet
	Earth probes
	Alligator clips & cables
	MAIN APPLICATIONS
	AC voltage measuring
	DC voltage measuring
	AC current measuring
	DC current measuring
	AC current measuring
	DC current measuring
	Resistance measuring

SYMBOL	DESCRIPTION
	Capacitance
	Continuity measuring
	Diode test
	Frequency measuring
	Temperature measuring
	hFE transistor
	Duty Cycle measuring
	Metal detection
	Lux level measuring
	Sound level measuring
	Revolutions per minute measuring
	Insulation test
	Power measuring
	FEATURES
	Auto power off
	Auto range
	Diode test
	Continuity test
	Max & min values
	Non-Contact voltage
	Low Impedance
	True root mean square
	Smartphone connectivity
	Transistor
	Back light display
	Data hold
	Work light

SYMBOL	DESCRIPTION
	Inrush current
	Data log
	Light indicator
	Acoustic indicator
	Metal detection
	RCD
	Luxes measurement
	Candel measurement
	Foot-Candel measurement
	Valid for LED light measuring
	Laser
	USB connection
	Over & under range alert
	AC weighting
	Average
	Timer
	Memory
	Dielectric absorption ratio / Polarization index
	Relative measurement
	Low battery display
	PC connection
	Emissivity
	Noise frequency weighting
	Valid for telephone cable line testing
	Valid for Ethernet cable testing
	Valid for TV/coaxial cable testing
	Broken cable testing



- Pocket format that facilitates product portability.
- Test leads integrated which facilitates the use and the storage.



More info

C-LOGIC 55

Digital multimeter

Item Code: CLOGIC55CBINT

Prev. Code: 1000004516

EAN Code: 8435394775487

UPC Code: 810053670996

CONTENTS



MAIN APPLICATIONS



DOMESTIC

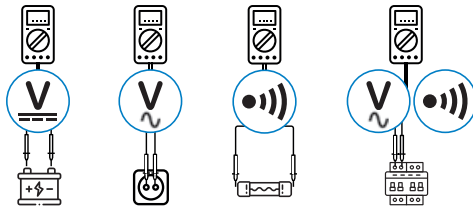

ELECTRONICS

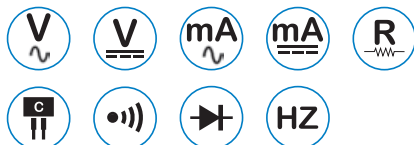
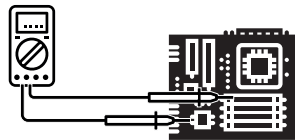

SPECIFICATIONS

AC VOLTAGE

300V

DC VOLTAGE

300V

AC CURRENT

200mA

RESISTANCE

2MΩ

DISPLAY COUNTS

2000



FEATURES

Display counts	2000	
Diode	Open Voltage	3.0V
Continuity Buzzer	< 50±20Ω	•
LBD	Low Battery Display	•

General

Power Supply	1×12V A23S Battery included
Product Size	120mmx70mmx18mm/4.7"x2.75"x0.7"
Product Weight	110g/0.23lb
Certificate	RoHs, CE, ETL
Safety Rating	CAT II 600V, CAT III 300V

PACKAGING & LOGISTICS INFORMATION

HS Code: 90303200

Carton box

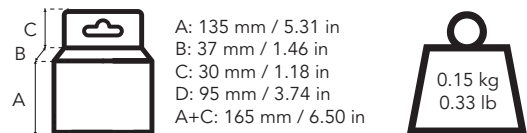

Export carton

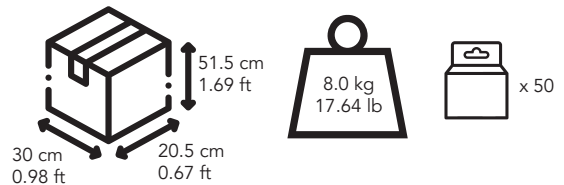

Pallet

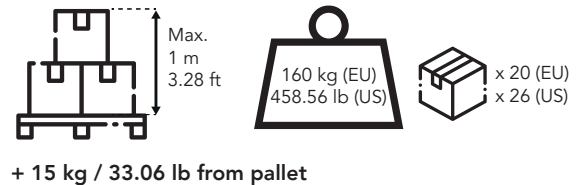



- Rubber housing for better comfort in use.
- Hinged bracket to facilitate table work.
- Resistance, diode, continuity and data hold.



C-LOGIC 520

Digital multimeter
 Item Code: CLOGIC520CBINT
 Prev. Code: 1000004517
 EAN Code: 8435394775494
 UPC Code: 810053670965



More info

CONTENTS



MAIN APPLICATIONS

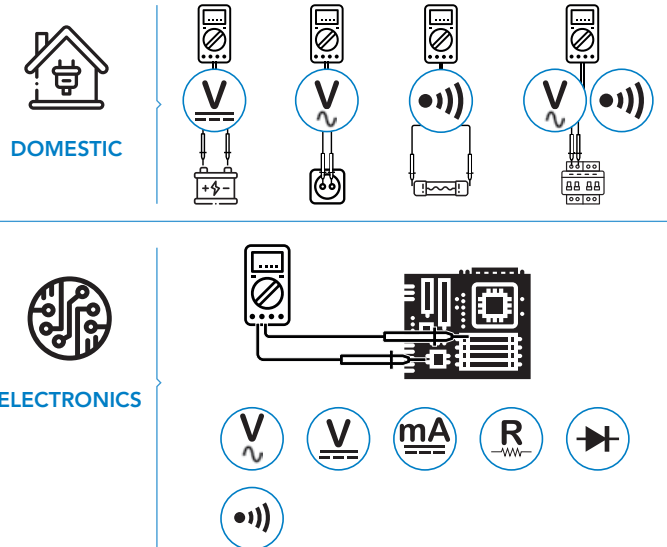

SPECIFICATIONS

AC VOLTAGE 600V	DC VOLTAGE 600V	DC CURRENT 10A
RESISTANCE 2MΩ	DISPLAY COUNTS 2000	

FEATURES

Display counts	2000
Diode	Open Voltage 3.0V
Continuity Buzzer	<50Ω
Data Hold	•
LBD	Low Battery Display •
Battery Test	1.5V/9V/12V •

General

Power Supply	1x9V6F22 NEDA 1604 Battery included
Product Size	148mmx73.5mmx50mm/5.8" x2.9"x1.96"
Product Weight	232g/0.51lb
Certificate	RoHs, CE, ETL
Safety Rating	CAT III 600V

PACKAGING & LOGISTICS INFORMATION

HS Code: 90303200

Check available packaging options.



- Rubber housing for better comfort in use.
- Hinged bracket to facilitate table work.
- AC /DC current ,AC/DC Voltage, capacitance, frequency, temperature and transistor.



C-LOGIC 5100

Digital multimeter
 Item Code: CLOGIC5100CBINT
 Prev. Code: 1000004525
 EAN Code: 8435394775562
 UPC Code: 810053670941

CONTENTS

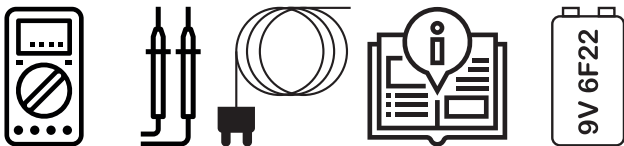

MAIN APPLICATIONS

DOMESTIC

ELECTRONICS

SPECIFICATIONS

AC VOLTAGE 600V	DC VOLTAGE 600V	AC CURRENT 10A
DC CURRENT 10A	RESISTANCE 200MΩ	CAPACITANCE 100μF
FREQUENCY 20kHz	TEMPERATURE -20°C~1000°C 1°F~1832°C	DISPLAY COUNTS 2000



FEATURES

Display counts	2000	
APO	Auto Power OFF	•
Transistor hFE	0~1000	•
Diode	Open Voltage	3.0V
Continuity Buzzer	<50Ω	
Data Hold	•	
LBD	Low Battery Display	•

General

Power Supply	1x9V 6F22 Battery included	
Product Size	188mm x 93mm x 50mm/7.4" x 3.7" x 1.96"	
Product Weight	380g/0.84lb	
Certificate	RoHs, CE, ETL	
Safety Rating	CAT III 600V	

PACKAGING & LOGISTICS INFORMATION

HS Code: 90303200

Carton box

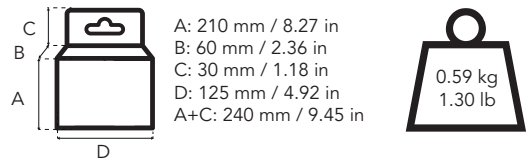

Export carton

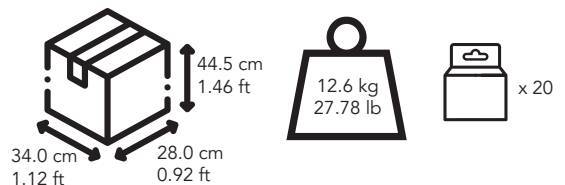

Pallet

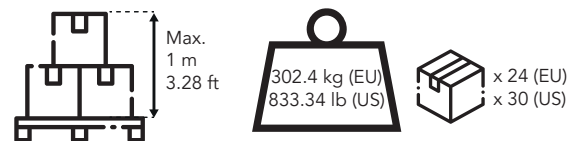

+ 15 kg / 33.06 lb from pallet



- Rubber housing for better comfort in use.
- Hinged bracket to facilitate table work.
- Professional reference. Industrial multimeter.



PRO



More info

C-LOGIC 5200

Digital multimeter
 Item Code: CLOGIC5200CBINT
 Prev. Code: 1000004526
 EAN Code: 8435394775593
 UPC Code: 810053671498

CONTENTS

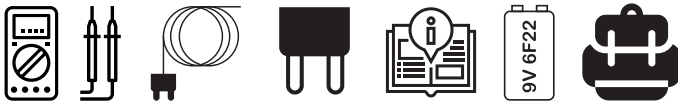

MAIN APPLICATIONS

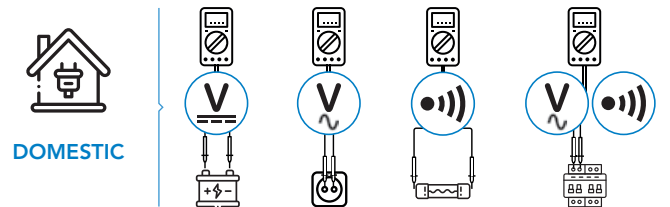

DOMESTIC

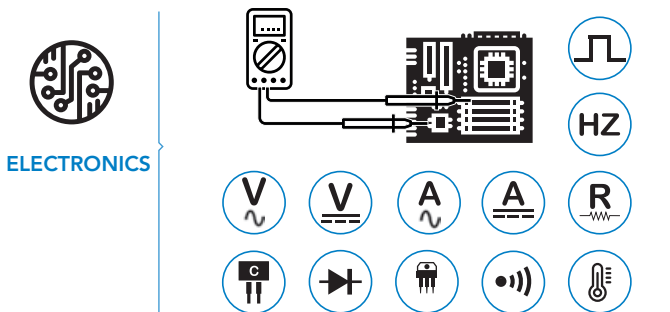

ELECTRONICS

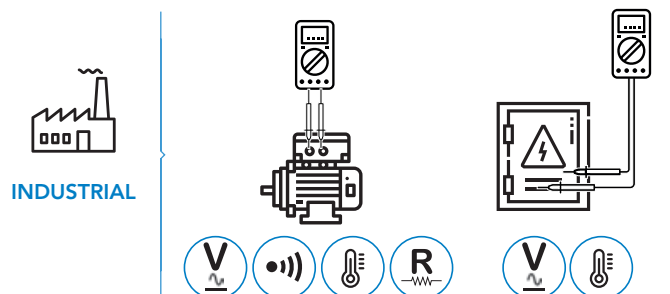

INDUSTRIAL

SPECIFICATIONS

AC VOLTAGE 1000V	DC VOLTAGE 1000V	AC CURRENT 10A
DC CURRENT 10A	RESISTANCE 66MΩ	CAPACITANCE 66mF
FREQUENCY 10kHz/66MHz	TEMPERATURE 0°C~1000°C 32°F~1832°F	DUTY CYCLE 1%~99.9%
DISPLAY COUNTS 6600	Apo	MAX MIN
AUTO	H	NCV

FEATURES

Display counts	6600
Auto Ranging	•
Manual Ranging	•
APO	Auto Power OFF
REL	Relative Measurement
NCV	Non-Contact Voltage Detector
Diode	Open Voltage
Continuity Buzzer	<50Ω
MAX/MIN	•
Data Hold	•
LBD	Low Battery Display
Display Backlight	•

General

Power Supply	1x9V 6F22 Battery included
Product Size	175mm x 85mm x 52mm/6.9" x 3.3" x 2.1"
Product Weight	420g/0.92lb
Certificate	RoHs, CE, ETL
Safety Rating	CAT III 1000V / CAT IV 600V

PACKAGING & LOGISTICS INFORMATION

HS Code: 90303200

Carton box

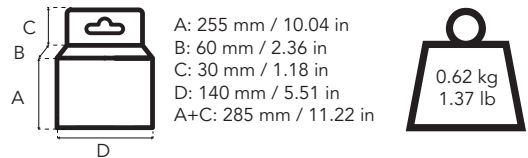

Export carton

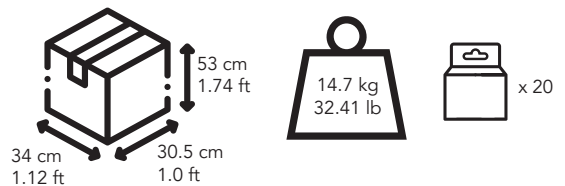

Pallet





- Industrial range multimeter up to 1000V
- TRMS
- Cat. IV 600V



PRO



More info

C-LOGIC 5600

Digital multimeter
 Item Code: CLOGIC5600CBINT
 Prev. Code: 301000059
 EAN Code: 8435394775654
 UPC Code: 810053671559

CONTENTS

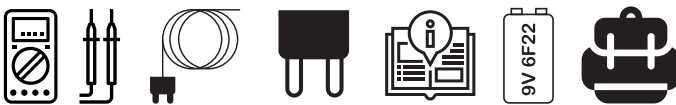

MAIN APPLICATIONS

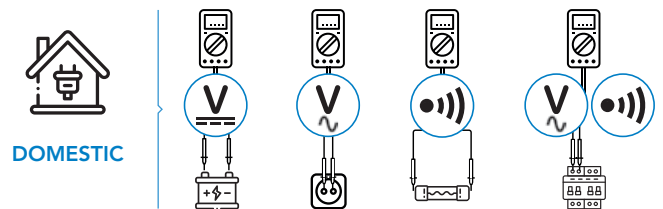

DOMESTIC

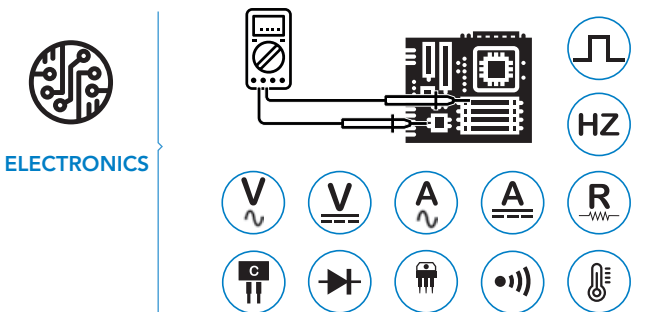

ELECTRONICS

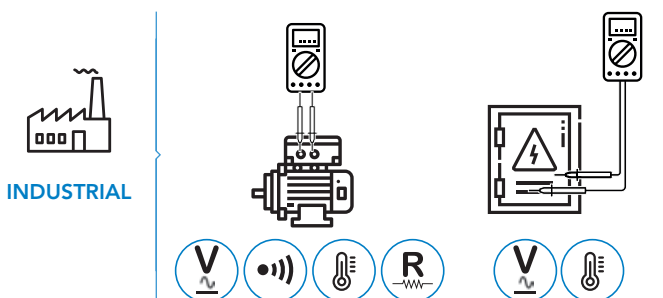

INDUSTRIAL

SPECIFICATIONS

AC VOLTAGE 1000V	DC VOLTAGE 1000V	AC CURRENT 10A
DC CURRENT 10A	RESISTANCE 66MΩ	CAPACITANCE 66mF
FREQUENCY 10kHz/66MHz	TEMPERATURE 0°C~1000°C 32°F~1832°F	DUTY CYCLE 1%~99.9%



FEATURES

Display counts	6600
Auto Ranging	•
Manual Ranging	•
REL	Relative Measurement
NCV	Non-Contact Voltage Detector
Diode	Open Voltage
Continuity Buzzer	<50Ω
Data Hold	•
LBD	Low Battery Display
Display Backlight	•
True RMS	True Root Mean Square
Low Z	Low Impedance Input Mode

General

Power Supply	1x9V 6F22 Battery included
Product Size	175mm x 85mm x 52mm/6.9" x 3.3" x 2.1"
Product Weight	420g/0.92lb
Certificate	RoHs, CE, ETL
Safety Rating	CAT III 1000V / CAT IV 600V

PACKAGING & LOGISTICS INFORMATION

HS Code: 90303200

Carton box

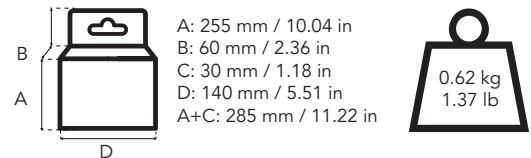

Export carton

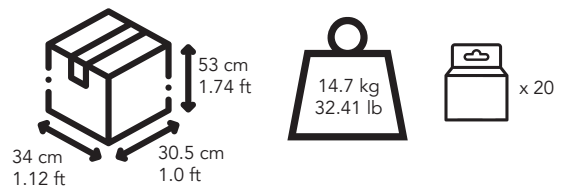

Pallet

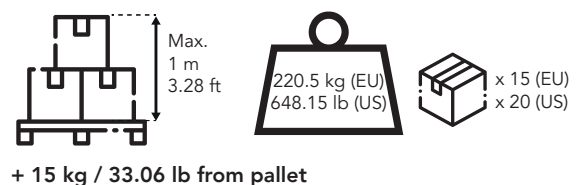



- Rubber housing for better comfort in use.
- Hinged bracket to facilitate table work
- Auto-range, relative, humidity, luminosity and sound level.
- Professional reference.



PRO



More info

C-LOGIC 5300

Digital multimeter
 Item Code: CLOGIC5300CBINT
 Prev. Code: 1000004527
 EAN Code: 8435394775609
 UPC Code: 810053671504

CONTENTS



MAIN APPLICATIONS

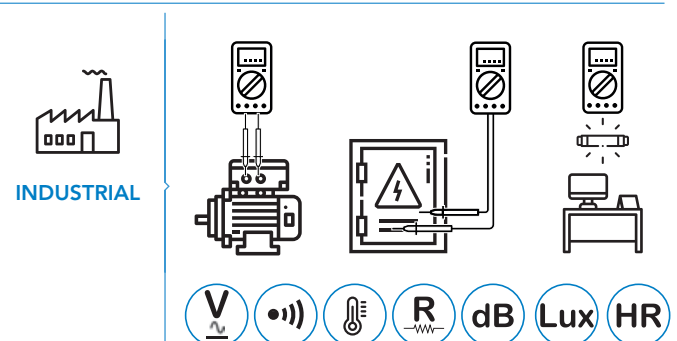
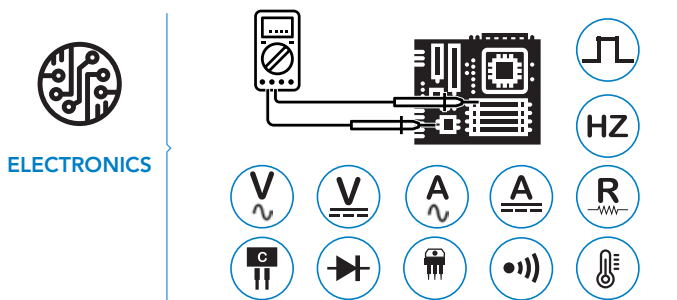
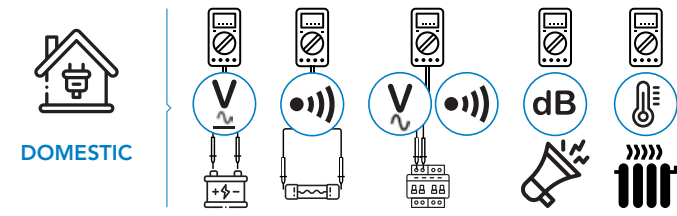

SPECIFICATIONS

AC VOLTAGE 600V	DC VOLTAGE 600V	AC CURRENT 10A
DC CURRENT 10A	RESISTANCE 40MΩ	CAPACITANCE 100μF
FREQUENCY >200kHz	DUTY CYCLE 0.1%~99.9%	SOUND LEVEL 40dB~100dB
LUMINOSITY 4000~40000Lux	REL. HUMIDITY 20%~95%	
TEMPERATURE -20°C~1000°C -4°F~1832°F	ENVIRONMENT 0°C~40°C 32°F~104°F	DISPLAY COUNTS 4000



FEATURES

Display counts	4000
Auto Ranging	•
Manual Ranging	•
APO	Auto Power OFF
°C/°F Selection	•
Diode	Open Voltage
Continuity Buzzer	<50Ω±20Ω
Data Hold	•
LBD	Low Battery Display
Display Backlight	•
Sound & Light Warning	For Incorrect insertion of the input plugs (S version only)

General

Power Supply	3x1.5V AAA Battery included
Product Size	195mm x 92mm x 55mm/7.7" x 3.6" x 2.2"
Product Weight	390g/0.86lb
Certificate	RoHs, CE, ETL
Safety Rating	CAT III 600V

PACKAGING & LOGISTICS INFORMATION

HS Code: 90303200

Carton box

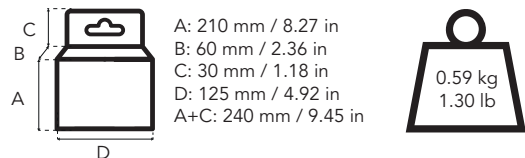

Export carton

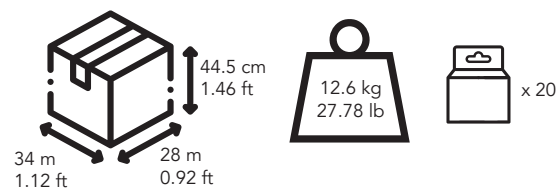

Pallet





- Smartphone connectivity
- APP allows readings on real time & records
- Rubber housing for better comfort in use.
- Hinged bracket to facilitate table work.



More info

C-LOGIC 5900

Digital multimeter Smartphone connectivity
 Item Code: CLOGIC5900CBINT
 Prev. Code: 301000068
 EAN Code: 8435394775517
 UPC Code: 810053671399

CONTENTS



MAIN APPLICATIONS

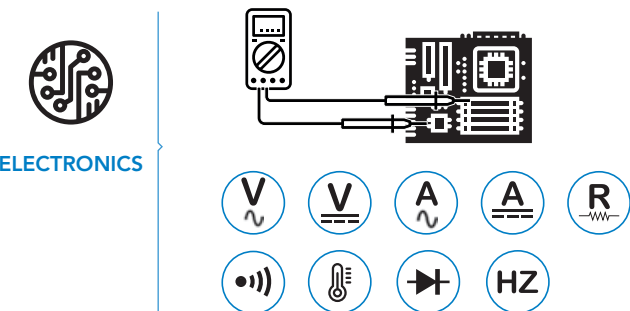
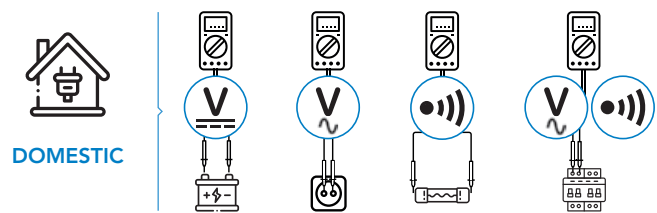

SPECIFICATIONS

AC VOLTAGE 600V	DC VOLTAGE 600V	AC CURRENT 10A
DC CURRENT 10A	RESISTANCE 40MΩ	CAPACITANCE 99.99mF
FREQUENCY (A) >10kHz	FREQUENCY (V) >1kHz	DUTY CYCLE 0.1%-99.9%

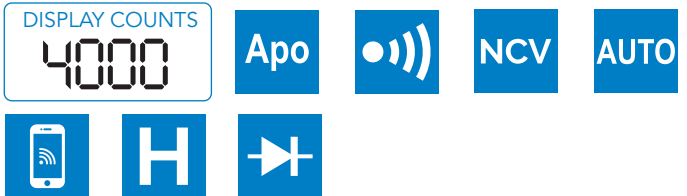

FEATURES

Display counts	4000
Auto Ranging	•
Manual Ranging	•
APO	Auto Power OFF
True RMS	For AC Voltage & AC Current
Diode	Open Voltage
Continuity Buzzer	<50Ω
Data Hold	•
LBD	Low Battery Display
NCV	Non-Contact Voltage Detector
Battery Tester	1.5V/9V
Wireless	APP connection

General

Power Supply	1×9V 6F22 Battery included
Product Size	188mm×92mm×50mm / 7.4"×3.6"×2.0"
Product Weight	380g/0.83lb
Certificate	RoHs, CE, ETL
Safety Rating	CAT III 600V

PACKAGING & LOGISTICS INFORMATION

HS Code: 90303200

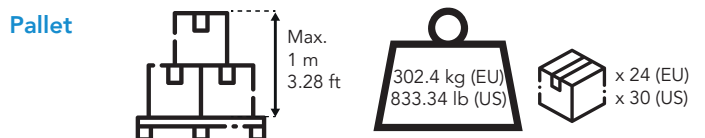
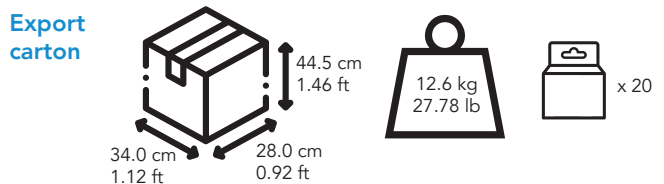
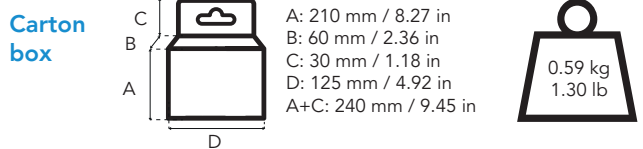

+ 15 kg / 33.06 lb from pallet



- Smart technology: auto recognition of measurement parameters.
- Avoid error in amateur users.
- Save time in pro users.



Info tech

C-LOGIC 580

Digital multimeter
 Item Code: CLOGIC580CBINT
 Prev. Code: 301000067
 EAN Code: 8435394775500
 UPC Code: 810053671603

CONTENTS



MAIN APPLICATIONS

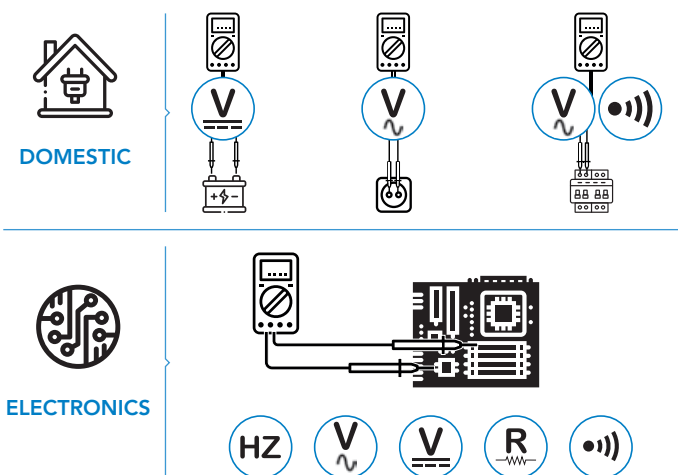

SPECIFICATIONS

AC VOLTAGE 600V	DC VOLTAGE 600V	RESISTANCE 10MΩ
FREQUENCY 3kHz	DUTY CYCLE 10%~90%	
DISPLAY COUNTS 6000		

MAIN FEATURES

FEATURES		
Display counts		6000
Auto range	Auto	•
APO	Auto Power Off	•
Dual Display		•
Continuity Buzzer	<40Ω	•
Data hold		•
MAX/MIN		•
Display Backlight		•
LBD	Low Battery Display	•
NCV	Non-Contact Voltage Detector	•

General

Power Supply	2x1.5V AAA Batteries included
Product Size	150mm×74mm×48mm/5.9"×2.9"×1.7"
Product Weight	220g/0.48lb
Certificate	RoHs, CE, ETL
Safety Rating	CAT III 600V

PACKAGING & LOGISTICS INFORMATION

HS Code: 90303200

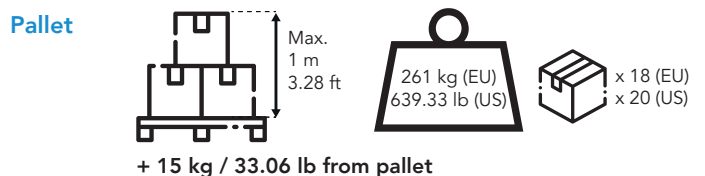
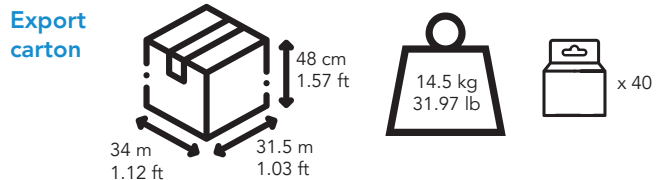
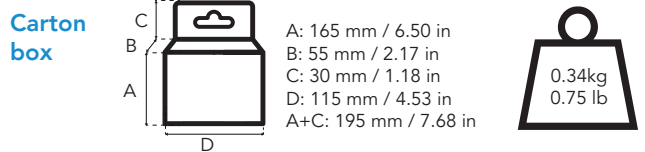



- VDC 1000V/VAC 750. Resistance, frequency, AC 1000, insulation test.
- Jaw size: 50mm.



More info

C-LOGIC 80

AC Clamp meter 100A
 Item Code: CLOGIC80CBINT
 Prev. Code: 301000071
 EAN Code: 8435394776712
 UPC Code: 810053671184

CONTENTS



MAIN APPLICATIONS

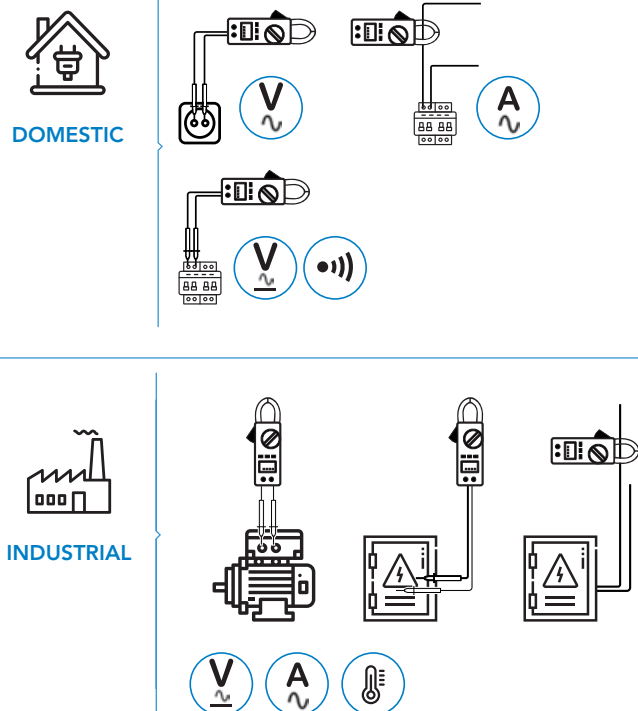

SPECIFICATIONS

AC VOLTAGE 750V	DC VOLTAGE 1000V	AC CURRENT 1000A
RESISTANCE 20kΩ	INSULATION TEST 2000MΩ	DISPLAY COUNTS 2000

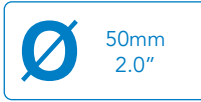

FEATURES

Display counts	2000
Jaw opening Ø	50mm / 2.0"
Continuity Buzzer	<100Ω
Data Hold	
LBD	Low Battery Display

General

Power Supply	1×9V 6F22 Battery included
Product Size	235mm×96mm×46mm / 9.25"×3.8"×1.8"
Product Weight	268g/0.59lb
Certificate	RoHs, CE, ETL
Safety Rating	CAT II 1000V, CAT III 600V

PACKAGING & LOGISTICS INFORMATION

HS Code: 90303200

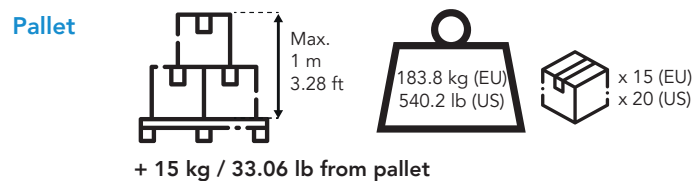
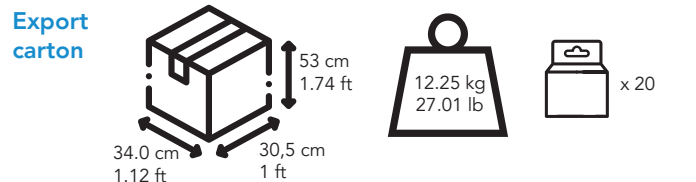
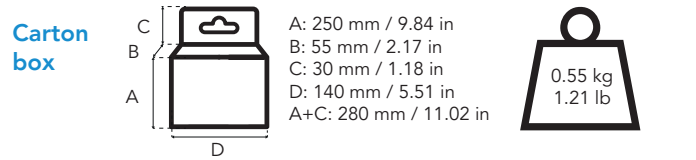



- Small size which facilitates its use and transport
- Jaw size 28mm.



More info

C-LOGIC 85

AC Clamp meter small jaw
 Item Code: CLOGIC85CBINT
 Prev. Code: 1000004518
 EAN Code: 8435394775524
 UPC Code: 810053671160

CONTENTS



MAIN APPLICATIONS

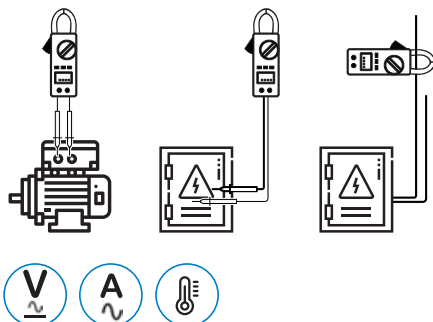
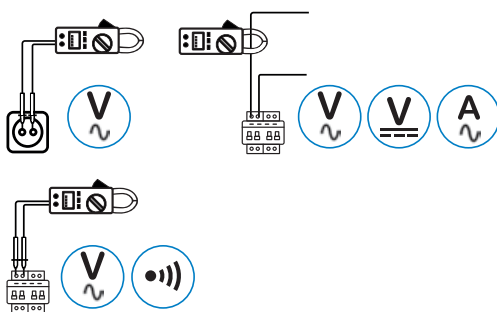

SPECIFICATIONS

AC VOLTAGE 600V	DC VOLTAGE 600V	AC CURRENT 400A
RESISTANCE 2kΩ	DISPLAY COUNTS 2000	Ø 28mm / 1.1"



FEATURES

Display counts	2000
Jaw Opening	Ø28mm/1.1'
Diode	Open Voltage 4.5V
Continuity Buzzer	<70Ω
Data hold	•
LBD	Low Battery Display

General

Power Supply	3×1.5V AAA Batteries included
Product Size	198mm×79mm×38mm/7.8"×3.1"×1.5"
Product Weight	195g/0.43lb
Certificate	RoHs, CE, ETL
Safety Rating	CAT III 600V

PACKAGING & LOGISTICS INFORMATION

HS Code: 90303200

Carton box

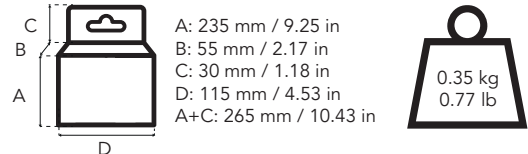

Export carton

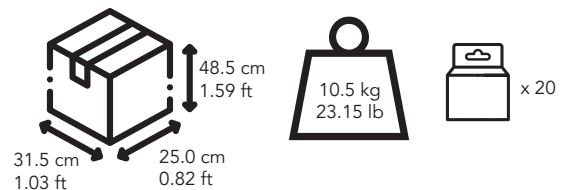

Pallet

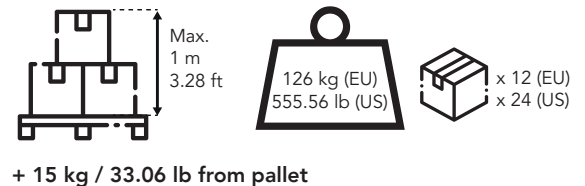



- AC/DC Current, allows work with renewable.
- Double injection housing which facilitates the grip and handling of the clamp.
- True RMS.



PRO



More info

C-LOGIC 8500

TRMS AC/DC clamp meter 1000A
 Item Code: CLOGIC8500CBINT
 Prev. Code: 1000004519
 EAN Code: 8435394775531
 UPC Code: 810053671283

CONTENTS



MAIN APPLICATIONS

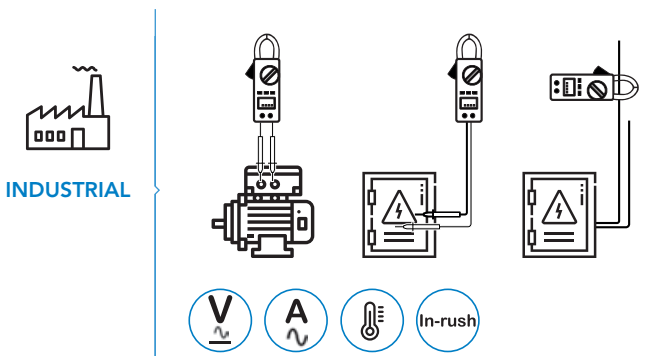
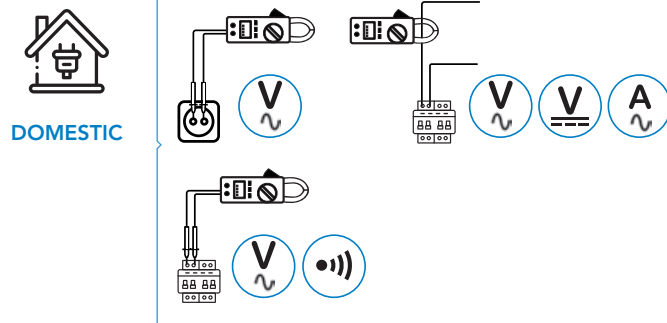

SPECIFICATIONS

AC VOLTAGE 750V	DC VOLTAGE 1000V	AC CURRENT 1000A
DC CURRENT 1000A	INRUSH CURRENT 1000A	RESISTANCE 60MΩ
CAPACITANCE 100mF	FREQUENCY (A/V) 1000Hz/10kHz	FREQUENCY (Hz/Duty) 10MHz
DUTY CYCLE 0.1%~99.9%	DISPLAY COUNTS 6000	40mm 1.6"



FEATURES

Auto Ranging		•
Manual Ranging		•
APO	Auto Power OFF	•
REL	Relative Measurement	•
Diode	Open Voltage	3.2V
Continuity Buzzer	<50Ω	•
Data Hold		•
MAX/MIN		•
LBD	Low Battery Display	•
True RMS	True Root Mean Square	•
Display Backlight		•
Work light		•
Inrush	Inrush Current Measurement	•

General

Power Supply	1×9V 6F22 Battery included
Product Size	238mm×92mm×50mm/9.37"×3.6"×1.9"
Product Weight	386g/0.85lb
Certificate	RoHs, CE, ETL
Safety Rating	CAT III 1000. CAT IV 600V

PACKAGING & LOGISTICS INFORMATION

HS Code: 90303200

Carton box

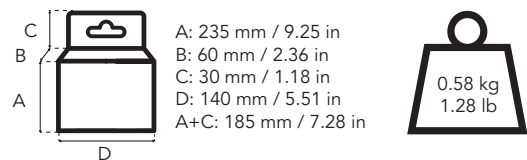

Export carton

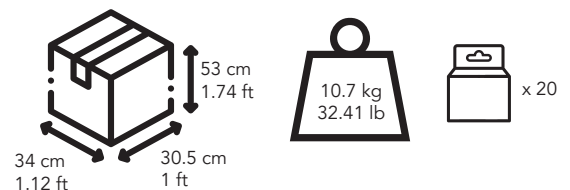

Pallet

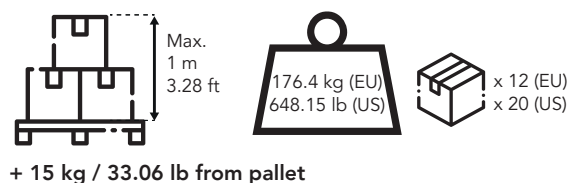



- Double injection housing, which facilitates the grip and handling of the clamp.
- Temperature.
- Work light, Non Contact Voltage (NCV).



C-LOGIC 810

AC clamp meter 600A
 Item Code: CLOGIC810CBINT
 Prev. Code: 1000004528
 EAN Code: 8435394775616
 UPC Code: 810053671191



More info

CONTENTS



MAIN APPLICATIONS

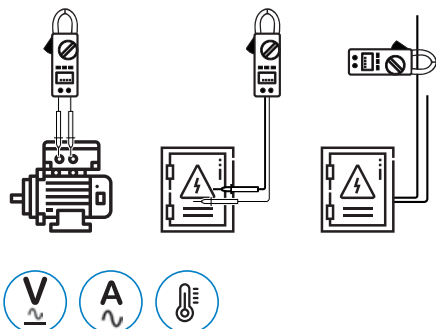
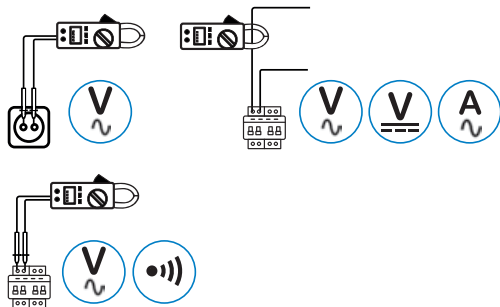

SPECIFICATIONS

AC VOLTAGE 600V	DC VOLTAGE 600V	AC CURRENT 600A
RESISTANCE 60MΩ	CAPACITANCE 60mF	FREQUENCY (A) 1kHz
FREQUENCY (V) 10kHz	FREQUENCY (Hz/Duty) 10MHz	DUTY CYCLE 0.5%~99.9%
TEMPERATURE -20°C~1000°C -4°F~1832°F	DISPLAY COUNTS 6000	26mm 1.0"



FEATURES

Display counts	6000
Jaw opening	Ø26mm/1.0"
Auto Ranging	•
Manual Ranging	•
APO	Auto Power OFF
NCV	Non-Contact Voltage Detector
Diode	Open Voltage
Continuity Buzzer	<60Ω
Data Hold	•
Display Backlight	•
Work light	•
LBD	Low battery display

General

Power Supply	3×1.5V AAA Batteries included
Product Size	218mm×78mm×35mm/8.9"×3.1"×1.4"
Product Weight	239g/0.53lb
Certificate	RoHs, CE, ETL
Safety Rating	CAT III 600V

PACKAGING & LOGISTICS INFORMATION

HS Code: 90303200

Carton box

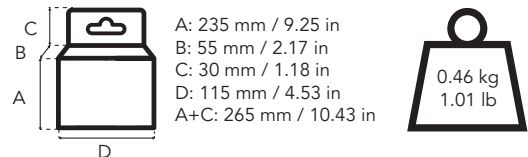

Export carton

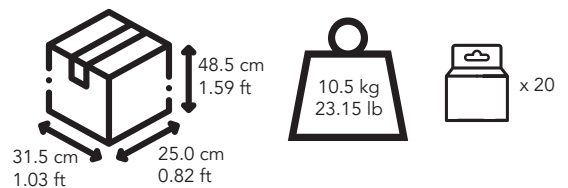

Pallet

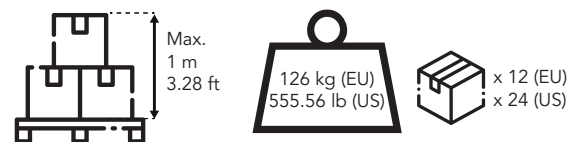

+ 15 kg / 33.06 lb from pallet



- Double injection housing, which facilitates the grip and handling of the clamp.
- True RMS.
- Professional reference, leakage clamp meter.



PRO



More info

C-LOGIC 8730

Leakage clamp meter with low-pass filter
 Item Code: CLOGIC8730CBINT
 Prev. Code: 301000056
 EAN Code: 8435394775623
 UPC Code: 810053671542

CONTENTS



MAIN APPLICATIONS

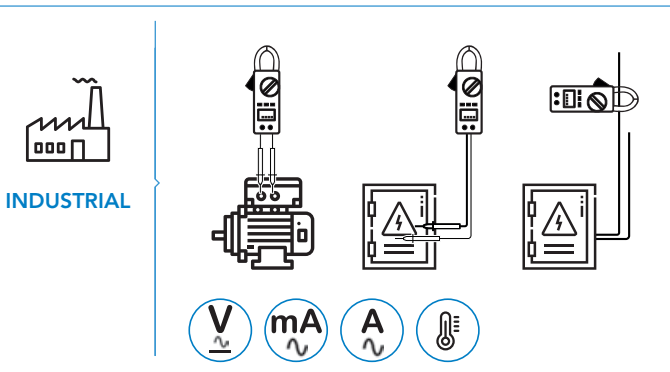
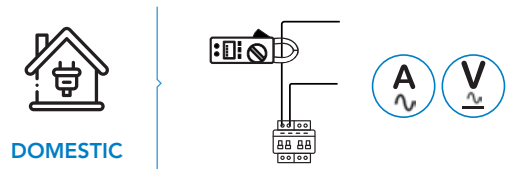

SPECIFICATIONS

AC VOLTAGE 600V	DC VOLTAGE 600V	AC CURRENT 150A
RESISTANCE 40MΩ	CAPACITANCE 40mF	TEMPERATURE -20°C~1000°C -4°F~1832°F
DISPLAY COUNTS 4000	Ø 30mm 1.2"	TRMS MAX MIN



FEATURES

Display counts	4000
Jaw opening	Ø30mm/1.2"
Auto Ranging	Auto
APO	Auto Power OFF
True RMS	For AC Voltage
LPF	Low Pass Filter Function (50/60Hz)
Zero	Zero Adjustment
MAX/MIN	
Diode	Open Voltage 3.2V
Continuity Buzzer	<40Ω
Data Hold	
LBD	Low Battery Display

General

Power Supply	2×1.5V AAA Batteries included
Product Size	213mm×62mm×38mm/8.39"×2.44"×1.5"
Product Weight	238g/0.52lb
Certificate	RoHs, CE, ETL
Safety Rating	CAT III 600V

PACKAGING & LOGISTICS INFORMATION

HS Code: 90303200

Carton box

A: 235 mm / 9.25 in
 B: 60 mm / 2.36 in
 C: 30 mm / 1.18 in
 D: 140 mm / 5.51 in
 A+C: 185 mm / 7.28 in

0.58 kg
1.28 lb

Export carton

53 cm / 1.74 ft
 34 cm / 1.12 ft
 30.5 cm / 1 ft

10.7 kg / 32.41 lb

x 20

Pallet

Max. 1 m / 3.28 ft

176.4 kg (EU) / 648.15 lb (US)

x 12 (EU) / x 20 (US)

+ 15 kg / 33.06 lb from pallet



- Rubber housing for better confort in use.
- Pen type.



SPECIFICATIONS

AC VOLTAGE
600V

DC VOLTAGE
600V

AC CURRENT
200mA

DC CURRENT
200mA

RESISTANCE
20MΩ

DISPLAY COUNTS

2000

MAX

▶

Apo

AUTO

H

•••

NCV

FEATURES

Display counts		2000
Auto Ranging	Auto	•
APO	Auto Power OFF	•
NCV	Non-Contact AC Voltage Detector Detection: >50V AC	•
Zero	Zero Adjustment	•
Logic Level test	0~1.5V (Green LED On) 1.5~3.5V (Green & Red LED On) 3.5~5V (Red LED On)	•
Diode	Open Voltage	1.5V
Continuity Buzzer	<50Ω	•
MAX	Maximum Value Hold	•
Data Hold		•
LBD	Low Battery Display	•
Housing	Double Molding	•

General

Power Supply	2×1.5V AAA Batteries included
Product Size	238mm×43mm×29mm/9.37"×1.7"×1.1"
Product Weight	112g/0.28lb
Certificate	RoHs, CE, ETL
Safety Rating	CAT III 600V

PACKAGING & LOGISTICS INFORMATION

HS Code: 90303200

Carton box

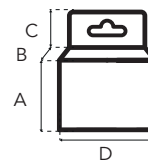

A: 235 mm / 9.25 in
B: 45 mm / 1.77 in
C: 30 mm / 1.18 in
D: 85 mm / 3.35 in
A+C: 265 mm / 10.43 in



Export carton

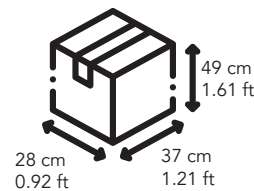

Pallet

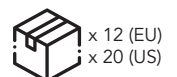
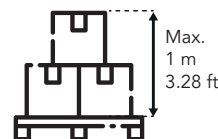

+ 15 kg / 33.06 lb from pallet

C-LOGIC 3200

Pen-type digital multimeter
Item Code: CLOGIC3200CBINT
Prev. Code: 1000004529
EAN Code: 8435394775630
UPC Code: 810053670798



More info

CONTENTS



MAIN APPLICATIONS

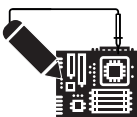
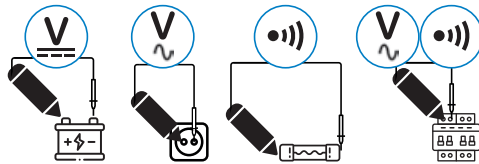



- Pen type which facilitates product portability.
- Metal detection.
- Sound and light signals.



C-LOGIC 35

Adjustable non contact AC voltage tester
 Item Code: CLOGIC35CBINT
 Prev. Code: 1000004521
 EAN Code: 8435394747903
 UPC Code: 810053670859



More info

SPECIFICATIONS

AC VOLTAGE
20-1000V



FEATURES

Frequency	50Hz~500Hz
Sound and light Indication	•
Red and Green LED Light	•
Double Molded Case	•
Metal Detecting Distance	<20mm
AC Voltage Sensitivity adjustment	•
Memory Sensitivity function	•
Auto Power Off	•
Low Battery Indication	•
Operating Temperature	-10°C~50°C

General

Storage Temperature	-20°C~60°C
Humidity	<85%RH
Altitude	<2000m
Product size	157mm×24mm×20 mm 6.18"×0.94"×0.78"
Product weight	42g/0.09lb
Certificate	CE/ETL/RoHS
Safety rating	CAT II 1000V/CAT III 600V
Power supply	2×12V A23S included

PACKAGING & LOGISTICS INFORMATION

HS Code: 90303200

Carton box

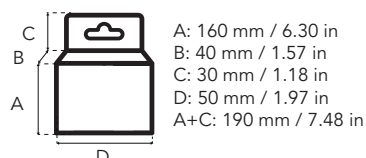

Export carton

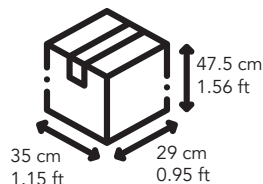

Pallet

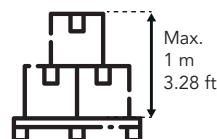

+ 15 kg / 33.06 lb from pallet

CONTENTS



MAIN APPLICATIONS

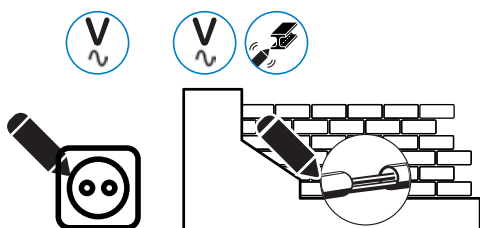



- Non contact voltage tester 1.000V
- Pen type.



C-LOGIC 25

Voltage Tester up to 1000V
 Item Code: CLOGIC25CBINT
 Prev. Code: 301000119
 EAN Code: 8435394777290
 UPC Code: 810053673331



More info

SPECIFICATIONS

AC VOLTAGE
90-1000Vac

FREQUENCY
50/60Hz



NCV

FEATURES

Voltage Range	90-1000V AC
Frequency	50/60HZ
NCV	Non-Contact AC Voltage Detector
Sound & LED indicator	

General

Power Supply	2 x1.5V AAA
Product Size	148 x 17 x 26 mm
Product Weight	23 gr. (without batteries)
Certificate	CE
Safety Rating	CAT II 1000V

PACKAGING & LOGISTICS INFORMATION

HS Code: 90303200

Carton box

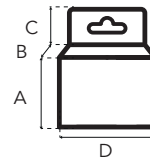

A: 152 mm / 5.98 in
 B: 32 mm / 1.25 in
 C: 23 mm / 0.9 in
 A+C: 175 mm / 6.88 in



Export carton

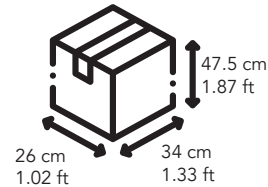

Pallet

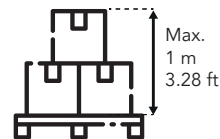

+ 15 kg / 33.06 lb from pallet

CONTENTS



MAIN APPLICATIONS

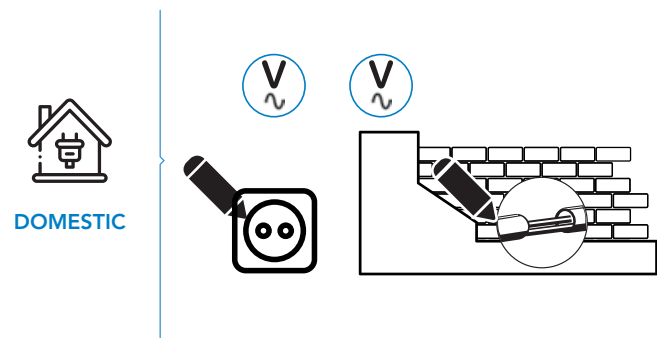

DOMESTIC

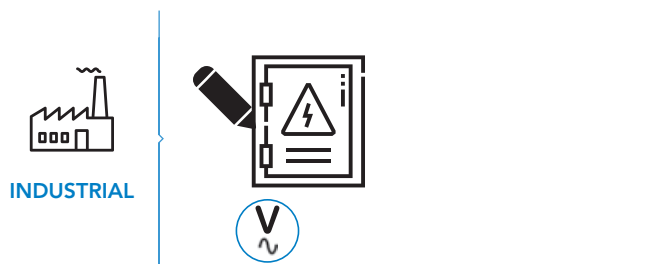

INDUSTRIAL



- Ergonomic design that facilitates its use
- Rubber housing for better confort in use.
- Small size, ideal for transport.



C-LOGIC 350

Two pole voltage tester
 Item Code: CLOGIC350CBINT
 Prev. Code: 1000004522
 EAN Code: 8435394747910
 UPC Code: 810053671290



More info

SPECIFICATIONS

AC VOLTAGE
 12-24-50-120-230-400V

FREQUENCY
 50Hz/60Hz

ACCURACY
 -30%~0%
 of indication



FEATURES

Altitude	<2000m
Operation time	Maximum 30s
Recovery time	10 minutes
Relative humidity	<80%RH
Temperature range	-10~55°C/14~131°F

General

Power Supply	N/A
Product Size	223mmx40mmx32 mm/8.78"x1.57"x1.26"
Product Weight	98.5g/0.26lb
Certificate	RoHs, CE, ETL
Safety Rating	CAT III 400V

PACKAGING & LOGISTICS INFORMATION

HS Code: 90303200

Carton box

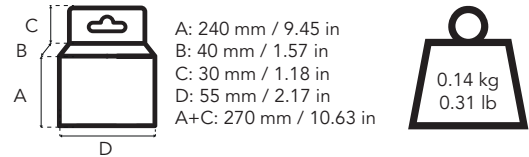

Export carton

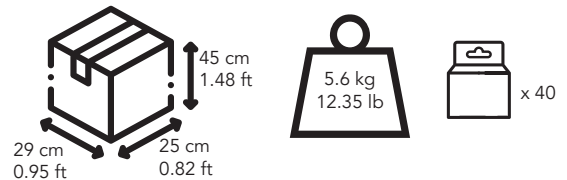

Pallet

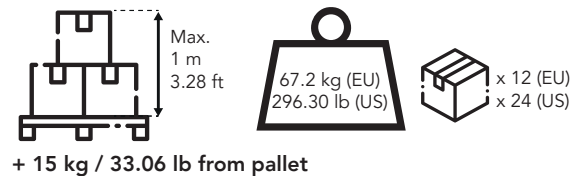

CONTENTS



MAIN APPLICATIONS

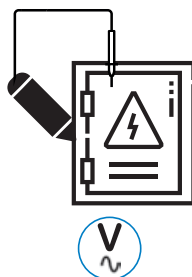
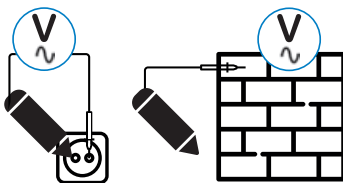



- Correct wiring tester
- Indication of disconnected poles L,N,E
- Sound and light led indicators



C-LOGIC 380
Socket tester



More info



ARTICLE	C-LOGIC 380	C-LOGIC 380US	C-LOGIC 380UK
Code	CLOGIC380CBINT	CLOGIC380USCBINT	CLOGIC380UKCBINT
Prev. Code	301000011	301000072	301000085
EAN	8435394747927	8435394776729	8435394776934
UPC	-	810053670897	-

CONTENTS

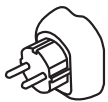

AVAILABLE SOCKETS



MAIN APPLICATIONS

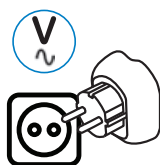

TONE	
ON	● ● ● ● CORRECT
o) PULSE	● ● ● ● MISSING EARTH
o) PULSE	● ● ● ● LIVE EARTH REVERSE
o) PULSE	● ● ● ● LIVE NEUTRAL REVERSE
o) PULSE	● ● ● ● MISSING NEUTRAL

SPECIFICATIONS

AC VOLTAGE
230V



Specifications

Voltage Range	230V
LED indication of the socket's wiring	Correct
	Missing Earth
	Live-Earth reverse
	Live-Neutral reverse
	Missing Neutral

General

Product Size	68mm×60mm×56mm/2.67"×2.36"×2.2"
Product Weight	60g/0.13lb
Certificate	RoHs, CE, ETL
Safety Rating	CAT II 230V

PACKAGING & LOGISTICS INFORMATION

HS Code: 90318000
HS Code (UK): 90303200

Carton box

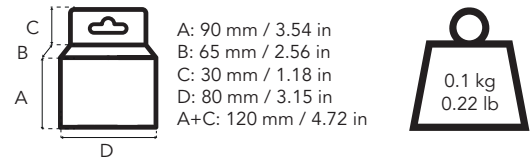

Export carton

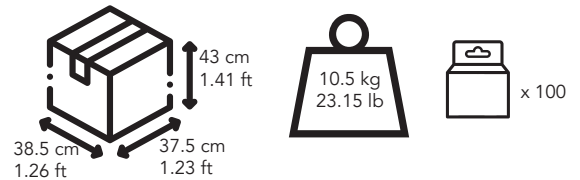

Pallet

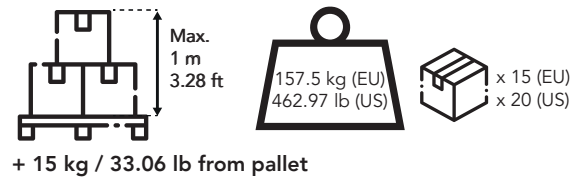



- Rubber housing for better confort in use.
- Valid for LED.
- Profesional reference.



More info

C-LOGIC 250

Digital light meter
 Item Code: CLOGIC250CBINT
 Prev. Code: 301000014
 EAN Code: 8435394747958
 UPC Code: 810053671511

CONTENTS



MAIN APPLICATIONS

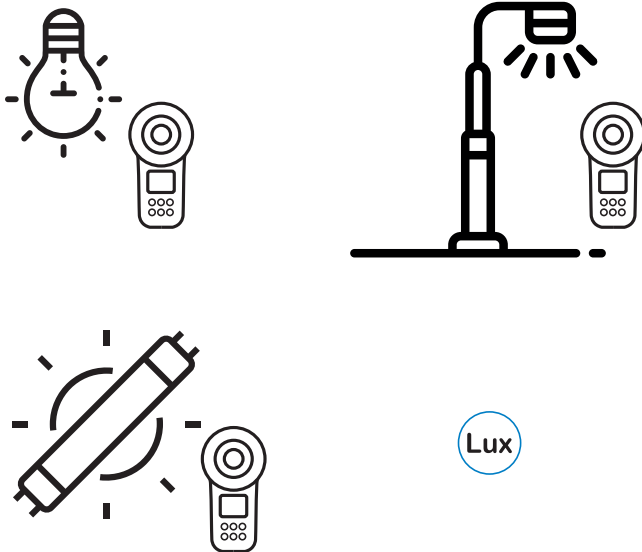

SPECIFICATIONS

LUX 20.000	DISPLAY COUNTS 2000	H REL
Apo	MAX MIN	Lux CD FC
		OK Led

FEATURES

Display counts	2000
Auto Ranging	•
Manual Ranging	•
APO	Auto Power OFF
MAX/MIN	•
REL	Relative Measurement
PEAK	Peak Measurement
ZERO	Zero Calibration
FC / Lux	FC / Lux / Unit Selection
Data Hold	•
Analog Bar	Analog Bar Indication
LBD	Low Battery Display

General

Power supply	1x9V 6F22 Battery included
Product size	170mm×89mm×43mm/6.7"×3.5"×1.7"
Product weight	420g/0.93lb
Certificate	RoHs, CE, ETL

PACKAGING & LOGISTICS INFORMATION

HS Code: 90303200

Carton box

A: 190 mm / 7.48 in
 B: 60 mm / 2.36 in
 C: 30 mm / 1.18 in
 D: 110 mm / 4.33 in
 A+C: 220 mm / 8.66 in

0.33 kg
0.73 lb

Export carton

40 cm / 1.31 ft
 33.5 cm / 1.10 ft
 24 cm / 0.79 ft

6.8 kg
14.99 lb

x 20

Pallet

Max. 1 m / 3.28 ft

149.6 kg (EU)
419.76 lb (US)

x 22 (EU)
x 28 (US)

+ 15 kg / 33.06 lb from pallet



- Rubber housing for better comfort in use.
- Small size ideal for transport.
- Temperature range up to 300°C.
- Data hold.



PRO



More info

C-LOGIC 230

Infrared thermometer
 Item Code: CLOGIC230CBINT
 Prev. Code: 1000004520
 EAN Code: 8435394775848
 UPC Code: 810053670002

CONTENTS



MAIN APPLICATIONS

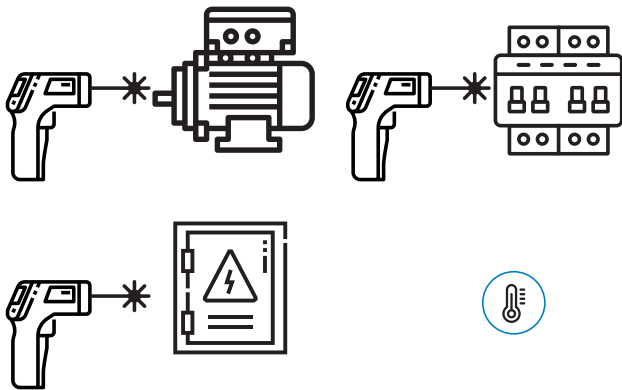

SPECIFICATIONS

TEMPERATURE -20°C~300°C -4°F~572°F	REL. HUMIDITY 10%~90%	RESOLUTION 0.1°C/0.2°F
---	---------------------------------	----------------------------------



FEATURES

Spectral Response	8-14 μm	•
Laser	<1mW / 630-670nm	•
°C/°F Selection		•
Response time	1 second	•
Relative Humidity	10%~90%	•
Laser Target Pointer		•
Reading Hold		•
MAX		•
MIN/AVG		•
Display Backlight		•
LBD	Low Battery Display	•

General

Power supply	2x1.5V AAA Batteries included
Product size	148mmx90mmx50mm/5.8"x3.54"x1.96"
Product weight	135g/0.3lb
Certificate	RoHs, CE, ETL

PACKAGING & LOGISTICS INFORMATION

HS Code: 90251900

Carton box

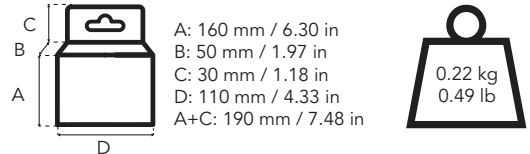

Export carton

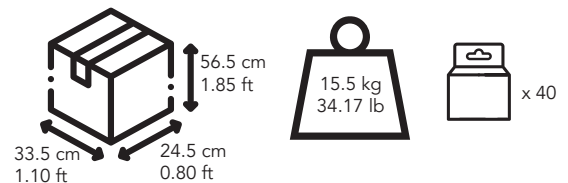

Pallet

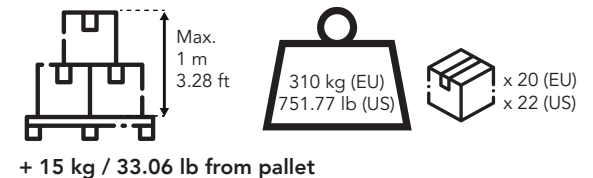



- Rubber housing for better confort in use.
- 40 m/s, Temperature, HR%
- Professional reference.



PRO



More info

C-LOGIC 280

Anemometer

Item Code: CLOGIC280CBINT

Prev. Code: 301000013

EAN Code: 8435394747941

UPC Code: 810053671306

CONTENTS



MAIN APPLICATIONS

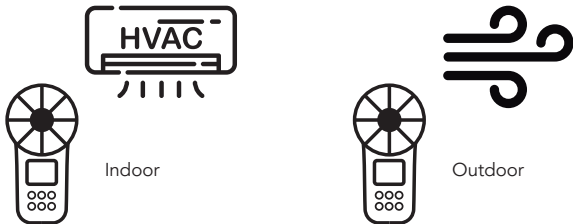

SPECIFICATIONS

Air speed (m/s) 40.00	Air speed (km/h) 144.0	Air speed (ft/s) 131.2
Air speed (mile/h) 90.00	Air speed (ft/min) 7874	Air speed (knots) 77.70
TEMPERATURE -10°C~60°C 14°F~140°F	RELATIVE HUMIDITY <20%~>80%	DISPLAY COUNTS 9999



FEATURES

	Range	Area	
Air Volume Unit	CFM: 0~999.9	0~9.999 ft ²	•
	CMM: 0~999.9	0~9.999 m ²	•
	CFS: 0~999.9	0~9.999 m ²	•
Display counts			9999
Flow Area Setting			•
MAX/MIN			•
Data Hold			•
Display Backlight			•
LBD	Low Battery Display		•

General

Power supply	1×9V 6F22 Battery included
Product size	165mm×85mm×38mm/6.5"×3.3"×1.5"
Product weight	168g/0.37lb
Certificate	RoHs, CE, ETL

PACKAGING & LOGISTICS INFORMATION

HS Code: 90303200

Carton box

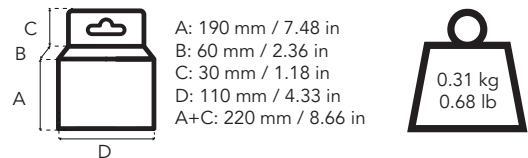

Export carton

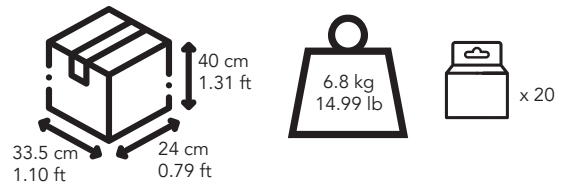

Pallet

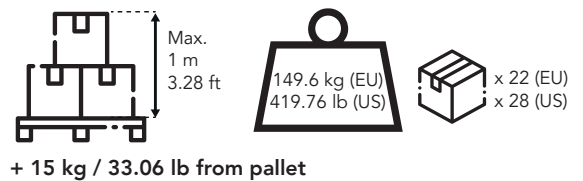



- Rubber housing for better confort in use.
- Up to 130dB.
- Categories A/C.
- Professional reference.



PRO



More info

C-LOGIC 290

Sound level meter
 Item Code: CLOGIC290CBINT
 Prev. Code: 301000015
 EAN Code: 8435394747965
 UPC Code: 810053671528

CONTENTS



MAIN APPLICATIONS

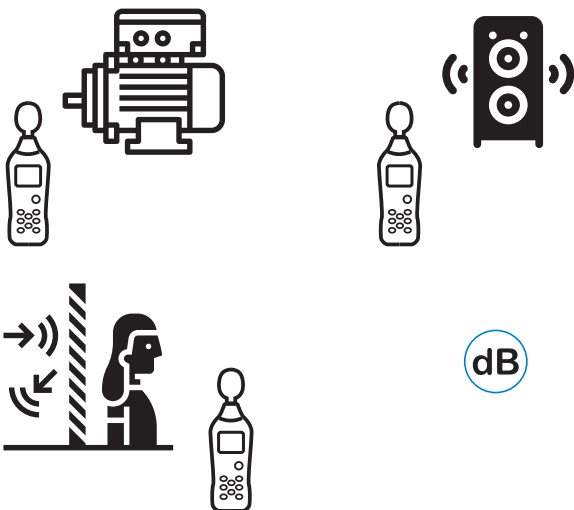

SPECIFICATIONS

SOUND PRESSURE

30dB~130dB

DISPLAY COUNTS

2000



FEATURES

Display counts		2000
Auto Ranging	Auto & Manual	•
APO	Auto Power Off	•
Dynamic	50dB	•
Frequency	30Hz~8kHz	•
Sample Rate	2 times/second	•
Fast/Slow	125ms/1 sec	•
A/C Weighting		•
Display Backlight		•
LBD	Low Battery Display	•
Analog Bar	Analog Bar Indication	•
UNDER/OVER	Over Range Indication	•

PACKAGING & LOGISTICS INFORMATION

HS Code: 90303200

Carton box

A: 230 mm / 9.06 in
 B: 45 mm / 1.77 in
 C: 30 mm / 1.18 in
 D: 95 mm / 3.74 in
 A+C: 260 mm / 10.24 in

0.34 kg
0.75 lb

Export carton

27 cm / 0.89 ft
 41 cm / 1.35 ft
 49.5 cm / 1.62 ft

15 kg / 33.07 lb

x 40

Pallet

Max. 1 m / 3.28 ft

120 kg (EU) / 264.55 lb (US)

x 8 (EU)
x 8 (US)

+ 15 kg / 33.06 lb from pallet



- Allows for easy AC current measurements.
- Separates Live conductor from the neutral and ground.
- Include terminals for voltage measurements.
- Compatible with Schuko.



C-LOGIC 370
AC Line splitter



More info



ARTICLE	C-LOGIC 370	C-LOGIC 370US	C-LOGIC 370UK
Code	CLOGIC370CBINT	CLOGIC370USCBINT	CLOGIC370UKCBINT
Prev. Code	301000063	301000073	301000086
EAN	8435394775692	8435394776736	8435394776941
UPC	-	810053670880	-

CONTENTS



AVAILABLE SOCKETS



MAIN APPLICATIONS

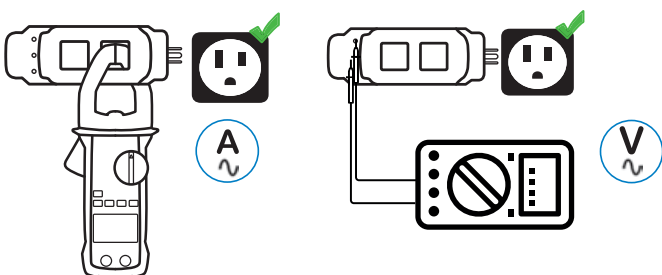

SPECIFICATIONS

AC VOLTAGE
250V

AC CURRENT
15A

X1 - X10
AC CURRENT

FEATURES

- Allows for easy AC current measurements
- Provides the ability to safely measure current
- Separates de Hot/Live conductor from the neutral and ground
- Voltage check sockets for easy power calculations

General

Product size	200mm×57mm×48mm/7.8"×2.2"×2.9"
Product weight	140g/0.3lb
Certificate	RoHs, CE
Safety rating	CAT II 600V

PACKAGING & LOGISTICS INFORMATION

HS Code: 90303200

Carton box

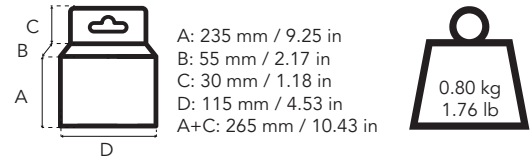

Export carton

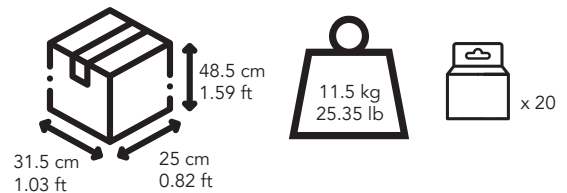

Pallet

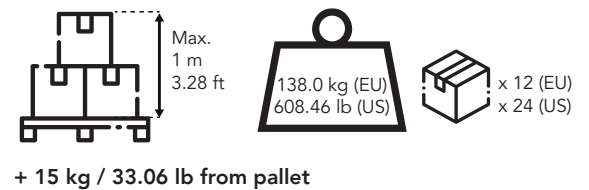



- Multifunction.
- Rubber housing for better confort in use.
- Small size ideal for transport.
- RJ11, RJ45 and coaxial cables.
- Cable tester and tracker.
- State of the telephone lines.



PRO



C-LOGIC 3400

Multifunction cable tracker
 Item Code: CLOGIC3400CBINT
 Prev. Code: 301000058
 EAN Code: 8435394775647
 UPC Code: 810053670842



More info



Applications

- Testing RJ45 cable
- Testing RJ11 cable
- Testing Coaxial Cable (BNC)
- Twisted-wire-pair cables (RJ45): 10Base-T, T568, T568, Token Ring
- Testing Cable's Shield Integrity
- Judge Continuity of the Cables or Wires
- Track the cables or wire, and diagnose the break Point
- Receive the tone signal on the cables or wires (telephone line)
- Identify the state in the working telephone line (clear, ringing, busy)
- Send a Single Solid or a Dual Alternating Tone to the Target Cables or Wires

FEATURES

- Send tone frequency: 1-5kHz
- Receive frequency: 100Hz~300kHz

General

Power supply	2x9V 6F22 included
Product size	206mm×84mm×55mm/8.1"×3.3"×2.1"
Product weight	330g/0.72lb
Certificate	CE/ETL/RoHS

PACKAGING & LOGISTICS INFORMATION

HS Code: 90303200

Carton box

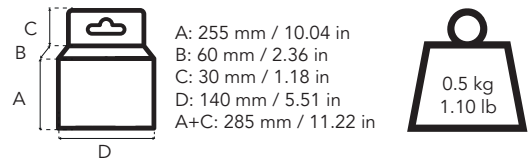

Export carton

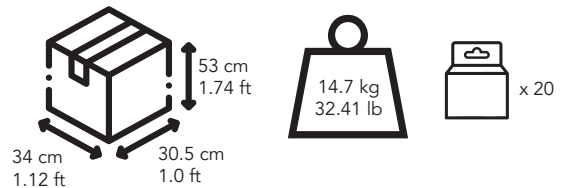

Pallet

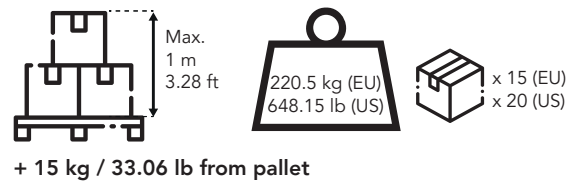

CONTENTS

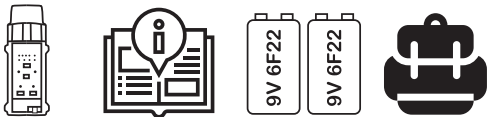

MAIN APPLICATIONS

Cable error tracking

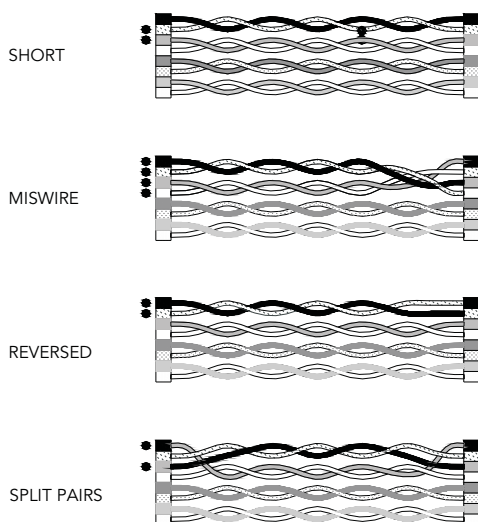



- Socket tester and circuit breaker finder.
- Sound and light signals
- Professional reference.



PRO



More info

C-LOGIC 3600

Circuit breaker finder



ARTICLE	C-LOGIC 3600	C-LOGIC 3600US	C-LOGIC 3600UK
Code	CLOGIC3600CBINT	CLOGIC3600USCBINT	CLOGIC3600UKCBINT
Prev. Code	301000062	301000074	301000087
EAN	8435394775685	8435394776743	8435394776958
UPC	-	810053670873	-

CONTENTS



AVAILABLE SOCKETS



MAIN APPLICATIONS

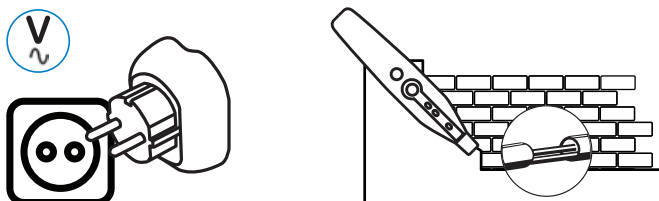

TONE	
ON	● ● ● CORRECT
o) PULSE	● ● ● MISSING EARTH
o) PULSE	● ● ● LIVE EARTH REVERSE
o) PULSE	● ● ● LIVE NEUTRAL REVERSE
o) PULSE	● ● ● MISSING NEUTRAL

SPECIFICATIONS

AC VOLTAGE

230V

SOCKET TEST

FEATURES

AC Voltage Range	230V
Socket Test	206mm×84mm×55mm/8.1"×3.3"×2.1"
Receiver + Transmitter	Quickly and easily identify the breaker connected to a specific socket
Transmitter (Socket Tester Mode) LED indication of the socket's wiring	Correct Missing earth Live-earth reverse Live-neutral reverse Missing neutral
	Work Light at the Head Points to the Target Area.
Receiver	Low Battery Indication Buzzer and LED instructions

General

Power Supply	1x9V 6F22 Battery	
Product Size	Receiver	198x40x50mm 7.8"×1.57"×1.97"
	Transmitter	71x64x55mm 2.8"×2.5"×2.16"
Product Weight	Receiver	126g/0.28lb
	Transmitter	60g/0.13lb
Certification	Receiver + Transmitter CE/ETL/RoHS	
Safety Rating	CAT II 600V	

PACKAGING & LOGISTICS INFORMATION

HS Code (EU): 90318000
HS Code (UK/US): 90303200

Carton box

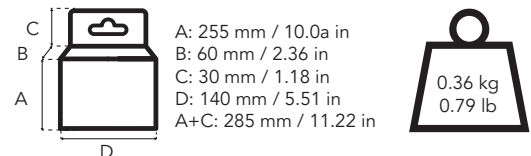

Export carton

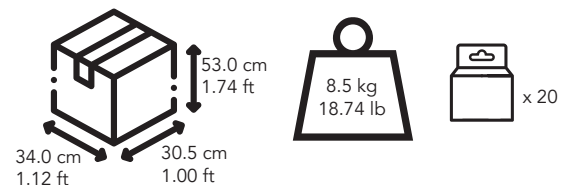

Pallet

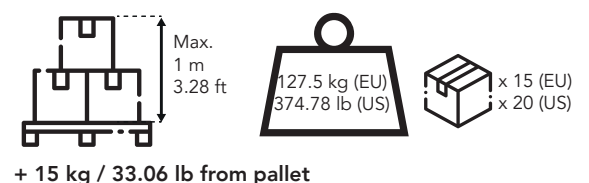



- Rubber housing for better confort in use.
- Non contact type.
- Professional reference.



PRO



More info

C-LOGIC 95

Non-contact type tachometer
 Item Code: CLOGIC95CBINT
 Prev. Code: 301000018
 EAN Code: 8435394747996
 UPC Code: 810053671535

CONTENTS



MAIN APPLICATIONS

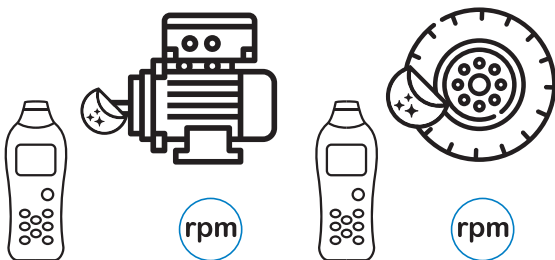

SPECIFICATIONS

RPM
50~99999



FEATURES

Measuring Distance	50mm~250mm	
APO	Auto Power Off	•
MAX/MIN		•
Data Logging	100 groups	•
Data Hold		•
Display Backlight		•
LBD	Low Battery Display	•

General

Power supply	4x1.5AAA Batteries included
Product size	155mm×60mm×27mm/6.1"×2.4"×1.1"
Product weight	120g/0.26lb
Certificate	RoHs, CE, ETL

PACKAGING & LOGISTICS INFORMATION

HS Code: 90303200

Carton box

A: 195 mm / 7.68 in
 B: 45 mm / 1.77 in
 C: 30 mm / 1.18 in
 D: 95 mm / 3.74 in
 A+C: 225 mm / 8.86 in

0.26 kg
0.57 lb

Export carton

27 cm / 0.89 ft
 41 cm / 1.35 ft
 41.5 cm / 1.36 ft

14.8 kg
32.63 lb

x 20

Pallet

Max. 1 m / 3.28 ft

236.8 kg (EU)
587.31 lb (US)

x 16 (EU)
x 18 (US)

+ 15 kg / 33.06 lb from pallet



- Motor & phase rotation tester
- Led light signals.



PRO



More info

C-LOGIC 98

Motor & Phase rotation tester
 Item Code: CLOGIC98CBINT
 Prev. Code: 301000064
 EAN Code: 8435394775708
 UPC Code: 810053671573

CONTENTS

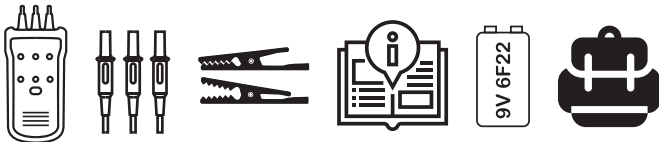

MAIN APPLICATIONS

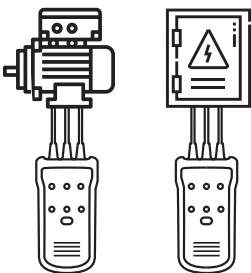

	⊗ ON	○ OFF	⊙ NOT DEFINED			
DISPLAY	↻	↻	↻	L1/A	L2/B	L3/C
Rotat.Right	○	⊗	⊗	⊗	⊗	⊗
Rotat.Left	⊗	○	⊗	⊗	⊗	⊗
L1 MISSING	⊙	⊙	○	⊗	⊗	⊗
L2 MISSING	⊙	⊙	⊗	○	⊗	⊗
L3 MISSING	⊙	⊙	⊗	⊗	⊗	○
Un=400/230V AC Ume=1...400V AC fn=2...400Hz						

SPECIFICATIONS

Nominal Voltage
Rotary Direction
1~400V AC

Nominal Voltage
Phase Indication
120~400V AC

Frequency
2~400Hz

Test Currents
(In per phase)
Less than 3.5 mA



FEATURES

Operating TEMP	0~40°C
Operating Altitude	2000m
Pollution Degree	2
Relative Humidity	15~80%RH

General

Power supply	1×9V 6F22 Battery included
Product size	130mm×72mm×32mm/5.1"×2.8"×1.3"
Product weight	252g/0.6lb
Certificate	CE, ETL
Safety Rating	CATIII 600V

PACKAGING & LOGISTICS INFORMATION

HS Code: 90303200

Carton box

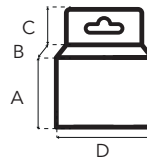

A: 238 mm / 9.37 in
 B: 64 mm / 2.52 in
 C: 30 mm / 1.18 in
 D: 168 mm / 6.61 in
 A+C: 268 mm / 10.55 in



Export carton

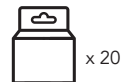
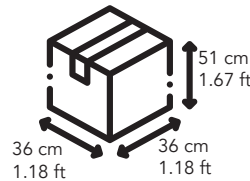

Pallet

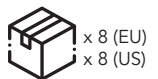
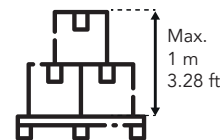

+ 15 kg / 33.06 lb from pallet

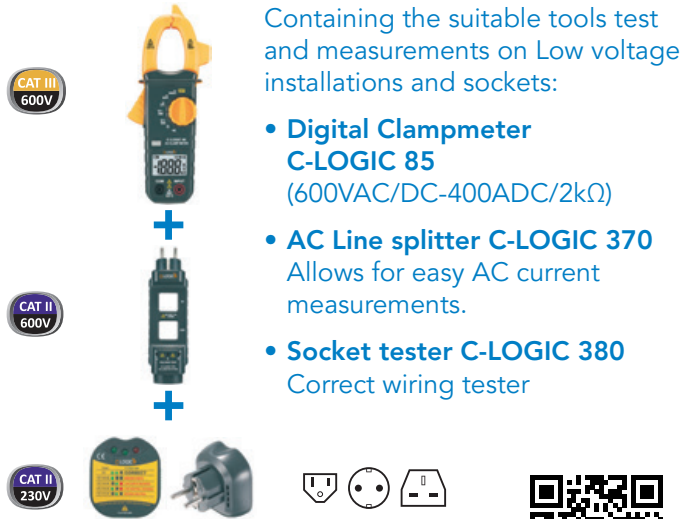

Containing the suitable tools test and measurements on Low voltage installations and sockets:

- **Digital Clampmeter C-LOGIC 85**
(600VAC/DC-400ADC/2kΩ)
- **AC Line splitter C-LOGIC 370**
Allows for easy AC current measurements.
- **Socket tester C-LOGIC 380**
Correct wiring tester

C-LOGIC 313

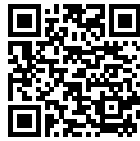

More info

ARTICLE	EU VERSION	US VERSION	UK VERSION
Code	Consult	Consult	Consult
Prev. Code	301000124	301000125	301000133
EAN	8435394777429	8435394777436	8435394777504
UPC	-	810053671825	-

CONTENTS

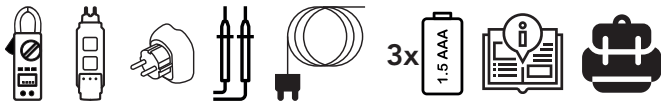

MAIN APPLICATIONS

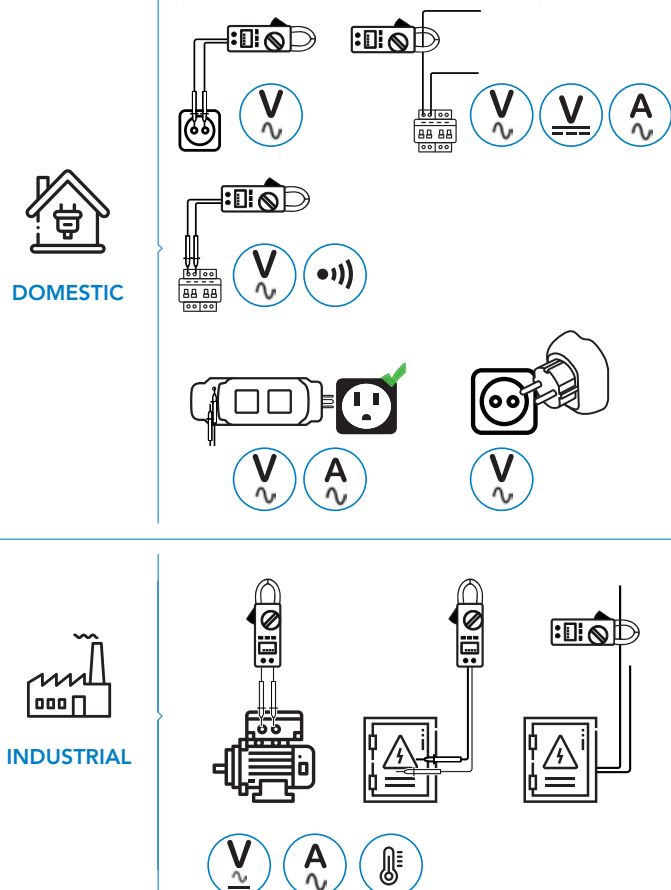

SPECIFICATIONS

• C-LOGIC 85 Digital Clampmeter

AC VOLTAGE 600V	DC VOLTAGE 600V	AC CURRENT 20V
RESISTANCE 2kΩ	DISPLAY COUNTS 2000	Ø 28mm 1.1"



• C-LOGIC 370 AC Line splitter

AC VOLTAGE 250V	DC VOLTAGE 15A	X1 - X10 AC CURRENT
--------------------	-------------------	------------------------

• C-LOGIC 380 Socket tester

AC VOLTAGE 12-1000V	
------------------------	--

C-LOGIC 85	C-LOGIC 370	C-LOGIC 380
Display counts: 2000	Easy AC current measurements	Voltage Range: 230V
Jaw Opening: Ø28mm/1.1"	Safe current measure	LED indication: correct, missing earth; Live-Earth reverse, Live-Neutral reverse, missing neutral
Diode: Open Voltage 4.5V	Separates de Hot/Live conductor from the neutral and ground	
Continuity Buzzer: <70Ω	Voltage check sockets for easy power calculations	

Data hold

Low Battery Display

General	C-LOGIC 85	C-LOGIC 370	C-LOGIC 380
---------	------------	-------------	-------------

Power Supply 3x 1.5V AAA
Batteries included

Product Size	198mm × 79mm × 38mm / 7.8"×3.1"×1.5"	200mm × 57mm × 48mm / 7.8"×2.2"×2.9"	68mm × 60mm × 56mm / 2.67"×2.36"×2.2"
Product Weight	195g/0.43lb	140g/0.31lb	60g/0.13lb
Certificate	RoHs, CE, ETL	RoHs, ETL	RoHs, CE, ETL
Safety Rating	CAT III 600V	CAT II 600V	CAT II 230V

PACKAGING & LOGISTICS INFORMATION

HS Code: 90303200

Different packaging options under request.

CAT III
600V



Containing the suitable tools test and measurements on Low voltage installations:

- **Digital Clampmeter C-LOGIC 85** (600VAC/DC-400ADC/2kΩ)



CAT III
600V



- **Digital multimeter C-LOGIC 540** Allows for easy AC current measurements.

C-LOGIC 314

Item Code: Consult
Prev. Code: 301000126
EAN Code: 8435394777443
UPC Code: 810053671832



More info

CONTENTS

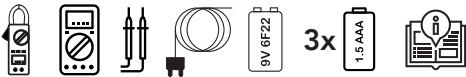

MAIN APPLICATIONS

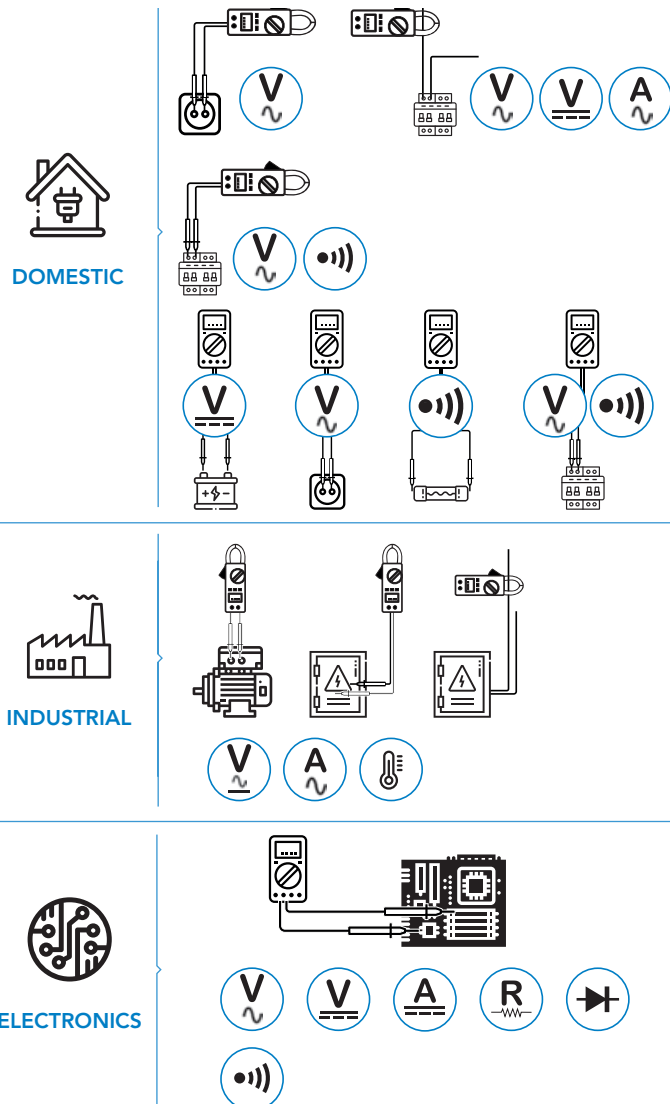

SPECIFICATIONS

• C-LOGIC 85 Digital Clampmeter

AC VOLTAGE 600V	DC VOLTAGE 600V	AC CURRENT 20V
RESISTANCE 2kΩ	DISPLAY COUNTS 2000	28mm 1.1"



• C-LOGIC 540 Digital multimeter

AC VOLTAGE 600V	DC VOLTAGE 600V	DC CURRENT 10A
RESISTANCE 2MΩ	DISPLAY COUNTS 2000	



	C-LOGIC 85	C-LOGIC 540
Display counts: 2000	Display counts: 2000	Display counts: 2000
Jaw Opening: Ø28mm/1.1'	Battery Test : 1.5V/9V/12V	
Diode: Open Voltage 4.5V	Diode: Open Voltage 3.0V	
Continuity Buzzer: <70Ω	Continuity Buzzer: <50Ω	
Data hold	Data hold	
Low Battery Display	Low Battery Display	
General	C-LOGIC 85	C-LOGIC 540
Power Supply	3x1.5V AAA Batteries included	1x9V6F22 NEDA 1604 Battery included
Product Size	198mm x 79mm x 38mm / 7.8" x 3.1" x 1.5"	145mm x 76mm x 40mm / 5.7" x 2.99" x 1.57"
Product Weight	195g/0.43lb	202g/0.44lb
Certificate	RoHs, CE, ETL	RoHs, CE, ETL
Safety Rating	CAT III 600V	CAT III 600V

PACKAGING & LOGISTICS INFORMATION

HS Code: 90303200

Different packaging options under request.



Containing the suitable tools test and measurements on Low voltage installations and sockets:

- **Voltage tester C-LOGIC 25**
Non contact voltage tester 1.000V
- **Socket tester C-LOGIC 380**
Correct wiring tester

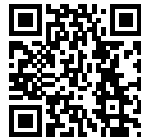

More info

C-LOGIC 311

ARTICLE	EU VERSION	US VERSION	UK VERSION
Code	Consult	Consult	Consult
Prev. Code	301000120	301000121	301000131
EAN	8435394777382	8435394777399	8435394777481
UPC	-	810053671801	-

CONTENTS



MAIN APPLICATIONS

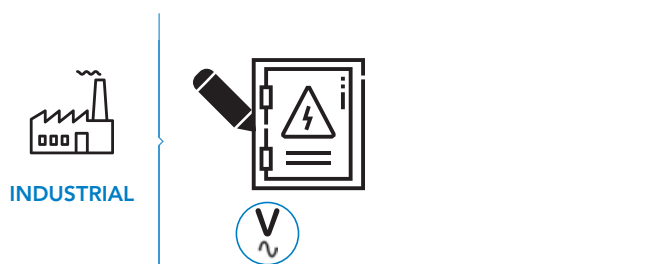
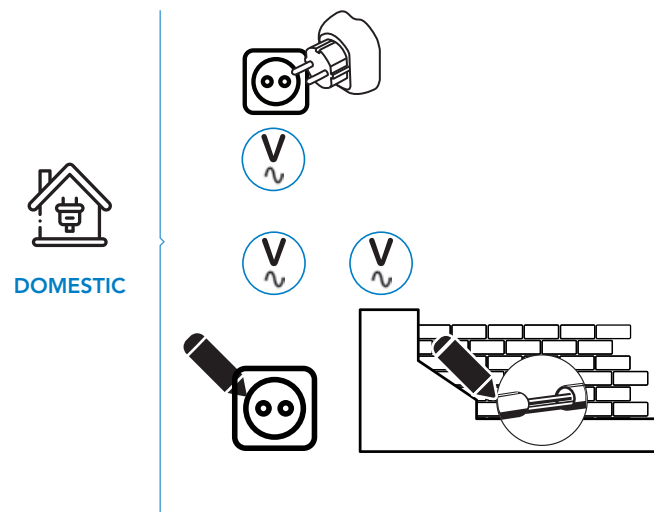

SPECIFICATIONS

• C-LOGIC 25 Voltage tester

AC VOLTAGE
1000V

FREQUENCY
50/60Hz

AC CURRENT
20V



• C-LOGIC 380 Socket tester

AC VOLTAGE
12-1000V



C-LOGIC 25	C-LOGIC 380	
Frequency: 50/60Hz	Voltage Range: 230V	
Sound and light Indication	LED indication: correct, missing earth; Live-Earth reverse, Live-Neutral reverse, missing neutral	
General	C-LOGIC 25	C-LOGIC 380
Power Supply		
Product Size		68mm × 60mm × 56mm / 2.67" × 2.36" × 2.2"
Product Weight		60g/0.13lb
Certificate	CE	RoHs, CE, ETL
Safety Rating	CAT II 1000V	CAT II 230V

PACKAGING & LOGISTICS INFORMATION

HS Code: 90303200

Different packaging options under request.

Containing the suitable tools test and measurements on Low voltage installations and sockets:

- **Digital multimeter C-LOGIC 540**
Allows for easy AC current measurements.
- **Voltage tester C-LOGIC 25**
Non contact voltage tester 1.000V
- **Socket tester C-LOGIC 380**
Correct wiring tester

C-LOGIC 312



More info

ARTICLE	EU VERSION	US VERSION	UK VERSION
Code	Consult	Consult	Consult
Prev. Code	301000122	301000123	
EAN	8435394777405	8435394777412	
UPC	-	810053671818	

CONTENTS



MAIN APPLICATIONS

DOMESTIC

INDUSTRIAL

ELECTRONICS

SPECIFICATIONS

• C-LOGIC 540 Digital multimeter

AC VOLTAGE 600V	DC VOLTAGE 600V	DC CURRENT 10A
RESISTANCE 2MΩ	DISPLAY COUNTS 2000	



• C-LOGIC 25 Voltage tester

AC VOLTAGE 1000V	FREQUENCY 50/60Hz			NCV
---------------------	----------------------	--	--	-----

• C-LOGIC 380 Socket tester

AC VOLTAGE 12-1000V		
------------------------	--	--

C-LOGIC 540	C-LOGIC 25	C-LOGIC 380
Display counts: 2000	Frequency: 50/60Hz	Voltage Range: 230V
Battery Test : 1.5V/9V/12V	Sound and light Indication	LED indication: correct, missing earth; Live-Earth reverse, Live-Neutral reverse, missing neutral
Diode: Open Voltage 3.0V		
Continuity Buzzer: <50Ω		
Data hold		
Low Battery Display		

General	C-LOGIC 540	C-LOGIC 25	C-LOGIC 380
Power Supply	1x9V6F22 NEDA 1604 Battery included		
Product Size	145mm x 76mm x 40mm / 5.7" x 2.99" x 1.57"		68mm x 60mm x 56mm / 2.67" x 2.36" x 2.2"
Product Weight	202g/0.44lb		60g/0.13lb
Certificate	RoHs, CE, ETL	CE	RoHs, CE, ETL
Safety Rating	CAT III 600V	CAT II 1000V	CAT II 230V

PACKAGING & LOGISTICS INFORMATION

HS Code: 90303200

Different packaging options under request.

CAT III
600V



Containing the suitable tools test and measurements on Low voltage installations and sockets:

- **Digital Clampmeter C-LOGIC 85**
(600VAC/DC-400ADC/2kΩ)
- **Voltage tester C-LOGIC 25**
Non contact voltage tester
1.000V

CAT II
1000V

C-LOGIC 315

Item Code: Consult
Prev. Code: 301000127
EAN Code: 8435394777450
UPC Code: 810053671849



More info

CONTENTS

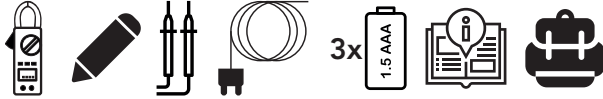

MAIN APPLICATIONS

DOMESTIC

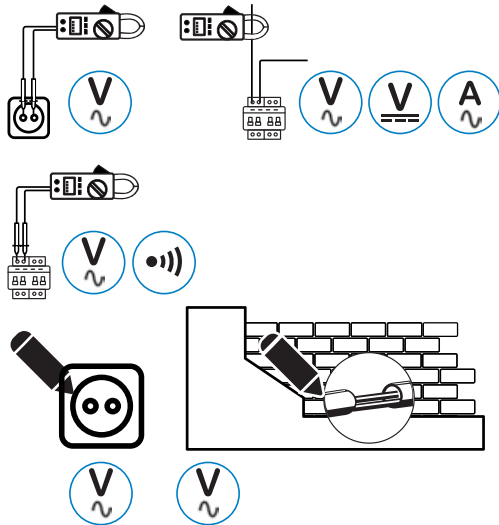

INDUSTRIAL

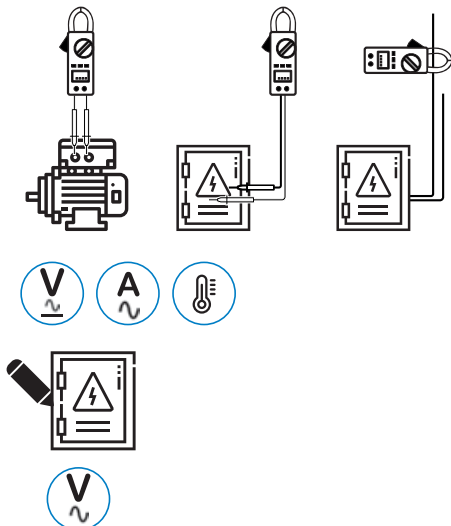

SPECIFICATIONS

• **C-LOGIC 85 Digital Clampmeter**

AC VOLTAGE 600V	DC VOLTAGE 600V	AC CURRENT 20V
RESISTANCE 2kΩ	DISPLAY COUNTS 2000	28mm 1.1"



• **C-LOGIC 25 Voltage tester**

AC VOLTAGE 1000V	FREQUENCY 50/60Hz
---------------------	----------------------



	C-LOGIC 85	C-LOGIC 25
Display counts: 2000		Frequency: 50/60Hz
Jaw Opening: Ø28mm/1.1'		Sound and light Indication
Diode: Open Voltage 4.5V		
Continuity Buzzer: <70Ω		
Data hold		
Low Battery Display		
General	C-LOGIC 85	C-LOGIC 25
Power Supply	3×1.5V AAA Batteries included	
Product Size	198mm × 79mm × 38mm / 7.8" × 3.1" × 1.5"	
Product Weight	195g/0.43lb	
Certificate	RoHs, CE, ETL	CE
Safety Rating	CAT III 600V	CAT II 1000V

PACKAGING & LOGISTICS INFORMATION

HS Code: 90303200

Different packaging options under request.



Containing the suitable tools test and measurements on Low voltage installations and sockets:

- **Digital multimeter C-LOGIC 540**
Allows for easy AC current measurements.
- **Voltage tester C-LOGIC 25**
Non contact voltage tester 1.000V
- **Electrical scissors**

C-LOGIC 316

Item Code: Consult
Prev. Code: 301000128
EAN Code: 8435394777467
UPC Code: 810053671856



More info

CONTENTS



MAIN APPLICATIONS

DOMESTIC

INDUSTRIAL

ELECTRONICS

SPECIFICATIONS

• C-LOGIC 540 Digital multimeter

AC VOLTAGE 600V	DC VOLTAGE 600V	DC CURRENT 10A
RESISTANCE 2MΩ	DISPLAY COUNTS 2000	



• C-LOGIC 25 Voltage tester

AC VOLTAGE 1000V	FREQUENCY 50/60Hz			NCV
---------------------	----------------------	--	--	------------

C-LOGIC 540	C-LOGIC 25	
Display counts: 2000	Frequency: 50/60Hz	
Battery Test : 1.5V/9V/12V	Sound and light Indication	
Diode: Open Voltage 3.0V		
Continuity Buzzer: <50Ω		
Data hold		
Low Battery Display		
General	C-LOGIC 540	C-LOGIC 25
Power Supply	1x9V6F22 NEDA 1604 Battery included	
Product Size	145mm x 76mm x 40mm / 5.7" x 2.99" x 1.57"	
Product Weight	202g/0.44lb	
Certificate	RoHs, CE, ETL	CE
Safety Rating	CAT III 600V	CAT II 1000V

PACKAGING & LOGISTICS INFORMATION

HS Code: 90303200

Different packaging options under request.



Containing the suitable tools test and measurements on Low voltage installations:

- **Digital multimeter C-LOGIC 540**
Allows for easy AC current measurements.
- **Cable stripper**
- **Electrical scissors**

C-LOGIC 317

Item Code: Consult
 Prev. Code: 301000129
 EAN Code: 8435394777474
 UPC Code: 810053671863



More info

CONTENTS



MAIN APPLICATIONS

DOMESTIC

ELECTRONICS

SPECIFICATIONS

• C-LOGIC 540 Digital multimeter

AC VOLTAGE 600V	DC VOLTAGE 600V	DC CURRENT 10A
RESISTANCE 2MΩ	DISPLAY COUNTS 2000	



C-LOGIC 540

Display counts: 2000

Battery Test : 1.5V/9V/12V

Diode: Open Voltage 3.0V

Continuty Buzzer: <50Ω

Data hold

Low Battery Display

General	C-LOGIC 540
Power Supply	1x9V6F22 NEDA 1604 Battery included
Product Size	145mm x 76mm x 40mm / 5.7" x 2.99" x 1.57"
Product Weight	202g/0.44lb
Certificate	RoHs, CE, ETL
Safety Rating	CAT III 600V

PACKAGING & LOGISTICS INFORMATION

HS Code: 90303200

Different packaging options under request.



Containing the suitable tools test and measurements on Low voltage installations:

- **Digital Multimeter C-LOGIC 50**
500Vac/dc-200mAdc/2MΩ
- **Handheld metal detector**
 - Suitable for indoor decoration use
 - When detect metal or voltage wire, the detector has sound and flash alarm
 - Can detect metal and voltage wire inside wall
- **Voltage detector**
VAC/DC 12-220V

C-LOGIC 310

Item Code: CLOGIC310CSINT
Prev. Code: 301000049
EAN Code: 8435394775555



More info

CONTENTS

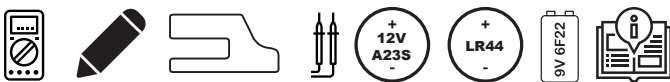

MAIN APPLICATIONS

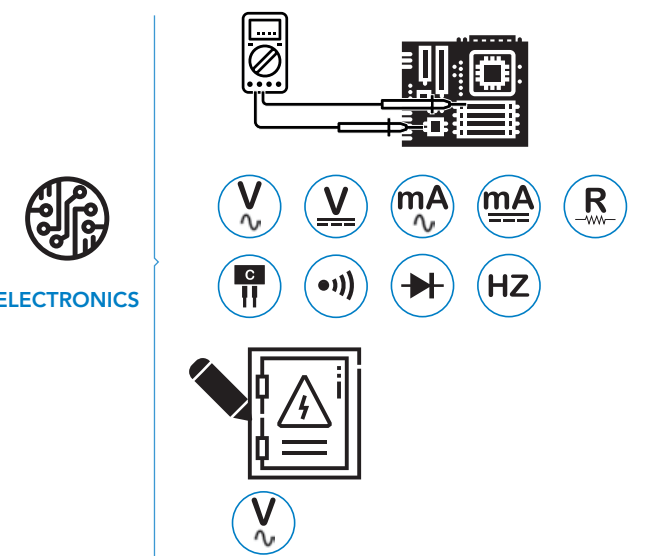
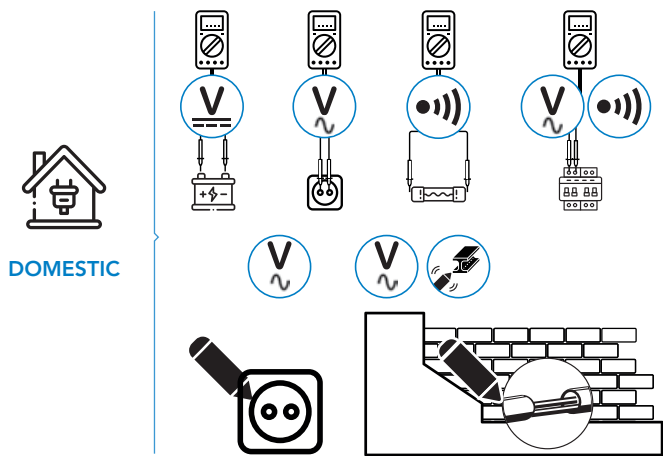

SPECIFICATIONS

• **C-LOGIC 50 Digital multimeter**

AC VOLTAGE 500V	DC VOLTAGE 500V	DC CURRENT 200mA
RESISTANCE 2MΩ	DISPLAY COUNTS 2000	

• **Voltage detector**

AC VOLTAGE 12-220VAC/DC		
----------------------------	--	--

• **Handheld metal detector**



General	C-LOGIC 50	Handheld metal detector	Voltage detector
Product size	120x70x20mm	150x78x24mm	140x26x20mm
Product Weight	202g/0.44lb		60g/0.13lb
Certificate	CE	CE	CE
Safety Rating	CAT III 600V	CAT II 300V	CAT II 300V

PACKAGING & LOGISTICS INFORMATION

HS Code: 90303200

Different packaging options under request.

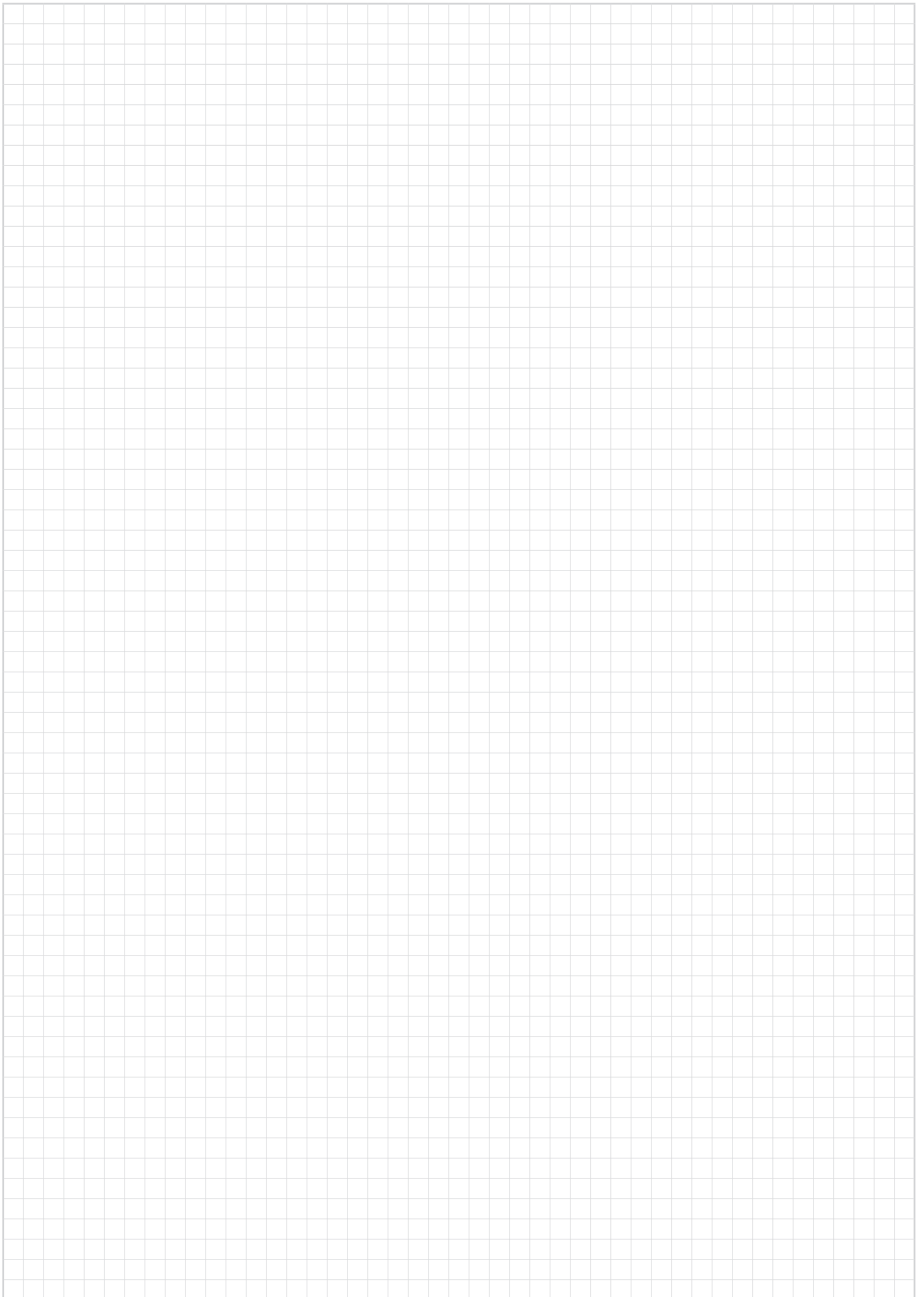



ENERGY SAVING

- MOVEMENT DETECTORS
- SENSOR LIGHTS
- LIGHT CONTROLS
- DOORCHIMES
- SECURITY DETECTORS
- THERMOSTATS & CHRONOTHERMOSTATS
- TIMES SWITCHES
- USN PLUGS

SYMBOL	DESCRIPTION	SYMBOL	DESCRIPTION
	Power Supply		Light indicators
	Adjustment twilight		Manual control
	Delay time		Auto mode
	Protection degree		Backlight display
	UV Protection		Frost protection
	Suitable for LED lights		Suitable for heating and cooling units
	Head rotation		Suitable for heating units
	E27 installation		Holiday mode
	Sound level		Programming intervals
	Adjustable detection area		Setting temperature range
	Additional output		Max. communication distance
	Lux level adjustment		Communication between devices
	Surge protection		Alexa connectivity
	Cable class		Android connectivity
	Battery class		iOS connectivity
	Number of melodies		TUYA connectivity



- Mini format for wall-mounting installation
- Horizontally and vertically adjustable head
- 180° coverage and maximum reach of 12 m.

ZCS TECHNOLOGY
Zero Cross Switching



C-LOGIC 610-MD

Wall mini movement detector
Item Code: CLOGIC610MD230VCBINT
Prev. Code: 301000021
EAN Code: 8435394748023



More info

CONTENTS

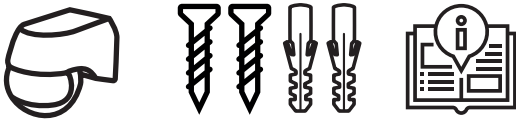

MAIN APPLICATIONS

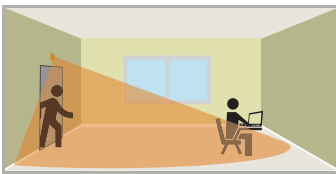

CONNECTION GUIDE

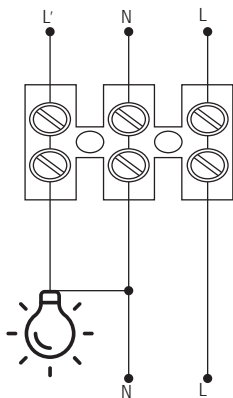

DIMENSIONS

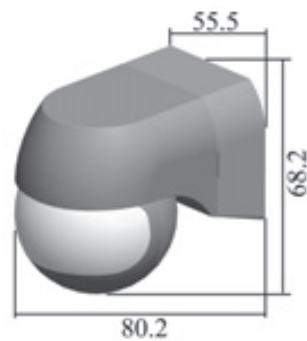

INSTALLATION

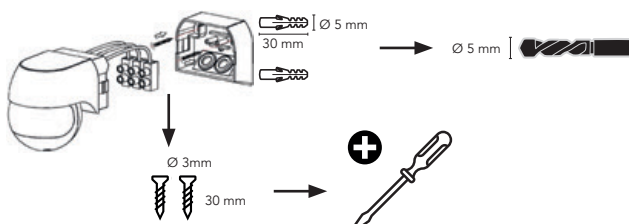

SPECIFICATIONS

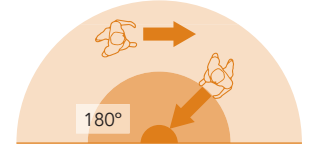
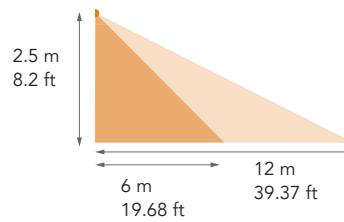

FEATURES

Angle of coverage	180°
Area of coverage	12 m (at 2.5 m height)
Adjustment twilight	3 - 2000 lux
Contact capacity	Incandescence: 800W Energy saving lamps: 400W LED lamps: 400W
Supply voltage	220-240VAC 50/60Hz

PACKAGING & LOGISTICS INFORMATION

HS Code: 85365080

Carton box

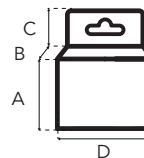

A: 85 mm / 3.35 in
B: 60 mm / 2.36 in
C: 35 mm / 1.38 in
D: 85 mm / 3.35 in
A+C: 120 mm / 4.72 in



Export carton

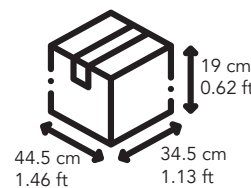

Pallet

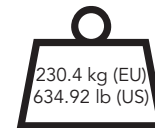
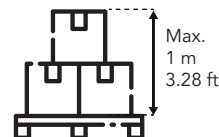

+ 15 kg / 33.06 lb from pallet



- Protection degree IP65, suited for outdoor use.
- Horizontally and vertically adjustable head
- 180° coverage and maximum reach of 12 m.

ZCS TECHNOLOGY
Zero Cross Switching



C-LOGIC 615-MD

Outdoor movement detector
Item Code: CLOGIC615MD230VCBINT
Prev. Code: 301000022
EAN Code: 8435394748030



More info

SPECIFICATIONS

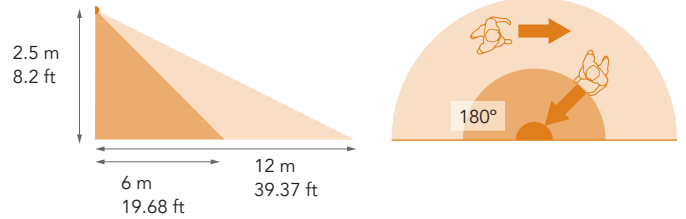

FEATURES

Angle of coverage	180°
Area of coverage	12 m (at 2.5 m height)
Adjustment twilight	3 - 2000 lux
Contact capacity	Incandescence: 800W Energy saving lamps: 300W LED lamps: 200W
Supply voltage	220-240VAC, 50/60Hz

PACKAGING & LOGISTICS INFORMATION

HS Code: 85365080

Carton box

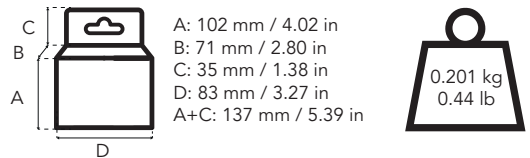

Export carton

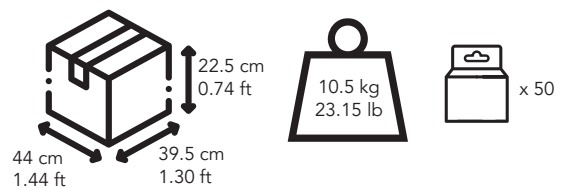

Pallet

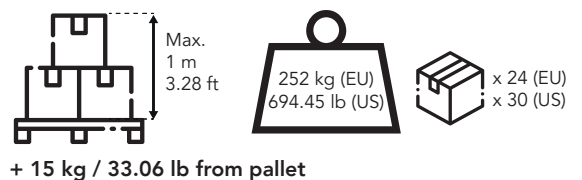

CONTENTS

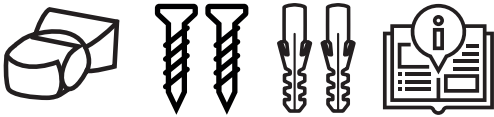

MAIN APPLICATIONS

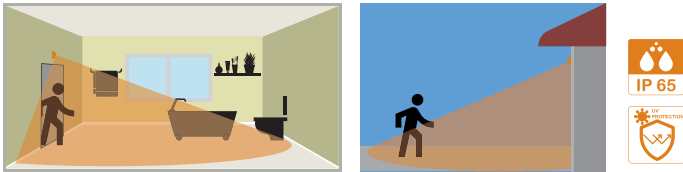

CONNECTION GUIDE

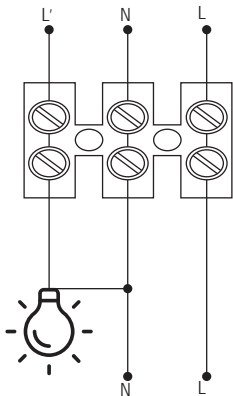

DIMENSIONS

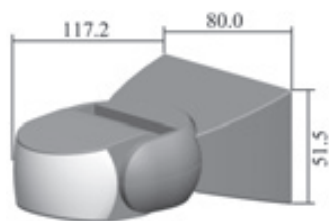

INSTALLATION

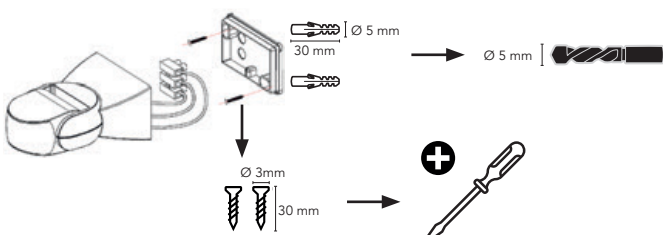



- Led indicator of movement detection
- Externally accessible potentiometer
- 360° detection coverage.

ZCS TECHNOLOGY
Zero Cross Switching



C-LOGIC 620-MD

Ceiling mounting movement detector
Item Code: CLOGIC620MD230VCBINT
Prev. Code: 301000023
EAN Code: 8435394748047



More info

CONTENTS



MAIN APPLICATIONS

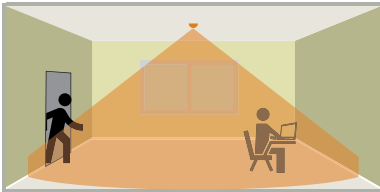

CONNECTION GUIDE

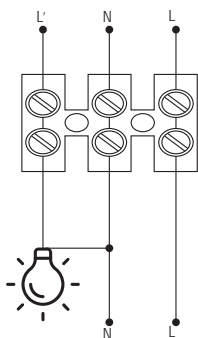

DIMENSIONS

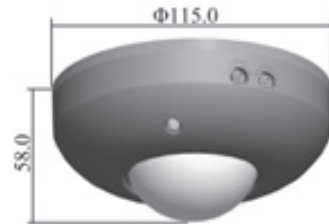

INSTALLATION

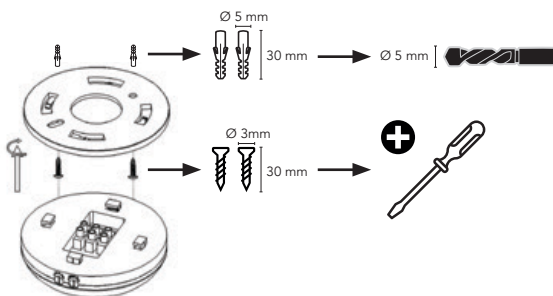

SPECIFICATIONS

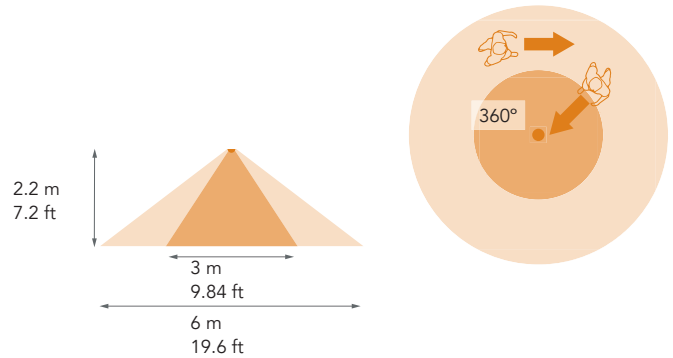

FEATURES

Angle of coverage	360°
Area of coverage	6 m diameter (at 2.2 m height)
Adjustment twilight	3 - 2000 lux
Contact capacity	Incandescence: 1200W Energy saving: 300W LED lamps: 300W
Supply voltage	220-240VAC 50/60Hz

PACKAGING & LOGISTICS INFORMATION

HS Code: 85365080

Carton box

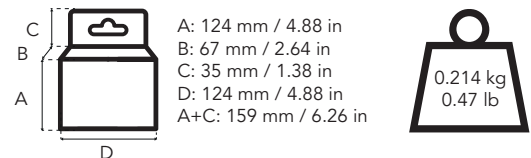

Export carton

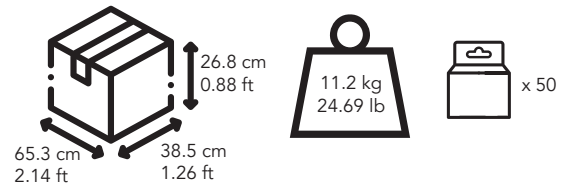

Pallet

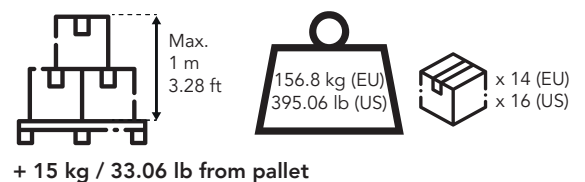



- Ceiling mounting slim line presence detector, only 2 cm high
- The same 360° coverage as other ceiling mounting conventional detectors
- 2000W relay with high switching power.

ZCS TECHNOLOGY
Zero Cross Switching



C-LOGIC 625-MD

Ceiling mounting slimline presence detector
Item Code: CLOGIC625MD230VCBINT
Prev. Code: 301000024
EAN Code: 8435394748054



More info

CONTENTS

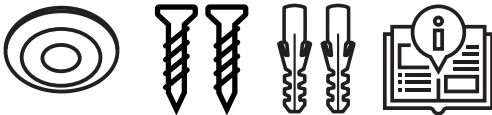

MAIN APPLICATIONS

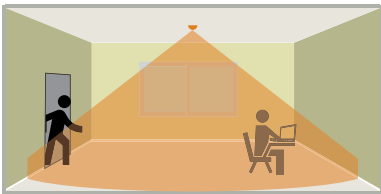

CONNECTION GUIDE

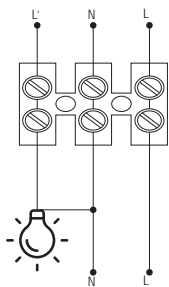

DIMENSIONS



INSTALLATION

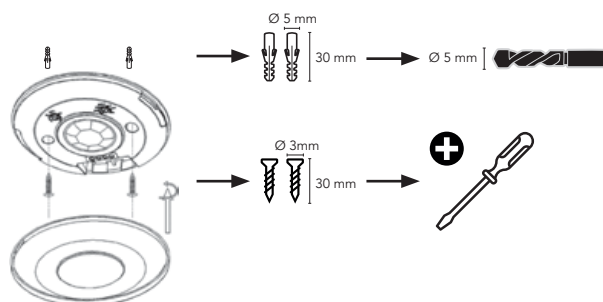

SPECIFICATIONS

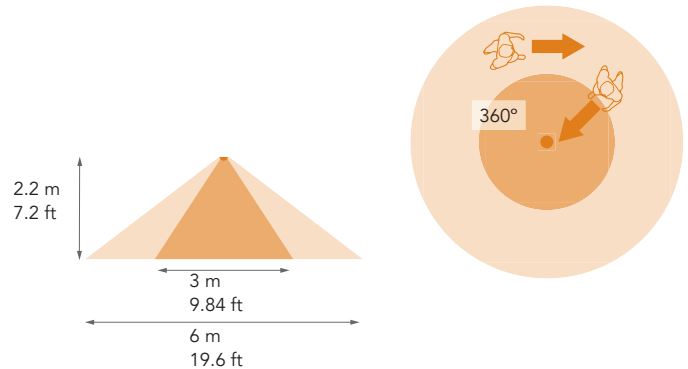

Installation height (h)	Coverage area (Ø)
2.2 m	6 m
3 m	10 m
3.5 m	10 m

FEATURES	
Angle of coverage	360°
Area of coverage	6 m (at 2.2 m height)
Adjustment twilight	3 - 2000 lux
Contact capacity	Incandescence: 2000W Energy saving lamps: 1000W LED lamps: 1000W
Supply voltage	220-240VAC 50/60Hz

PACKAGING & LOGISTICS INFORMATION

HS Code: 85365080

Carton box

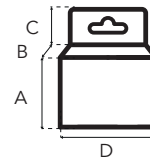

A: 124 mm / 4.88 in
B: 35 mm / 1.38 in
C: 30 mm / 1.18 in
D: 120 mm / 4.72 in
A+C: 154 mm / 6.06 in



Export carton

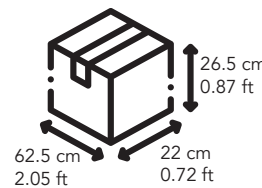

Pallet

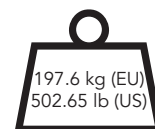
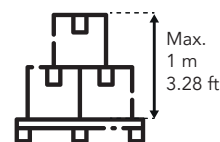

+ 15 kg / 33.06 lb from pallet



- Ceiling mounting presence detector with 3 sensors.
- Large detection area 20m diameter.
- 2000W relay with high switching power.

ZCS TECHNOLOGY
Zero Cross Switching



C-LOGIC 630-MD

Presence detector for large areas and corridors
Item Code: CLOGIC630MD230VCBINT
Prev. Code: 301000025
EAN Code: 8435394748061



More info

CONTENTS



MAIN APPLICATIONS

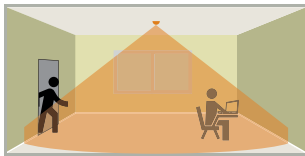

CONNECTION GUIDE

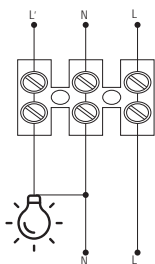

DIMENSIONS

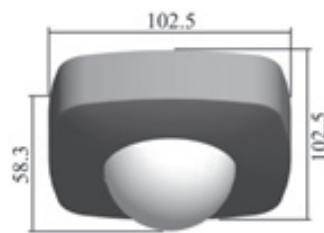

INSTALLATION

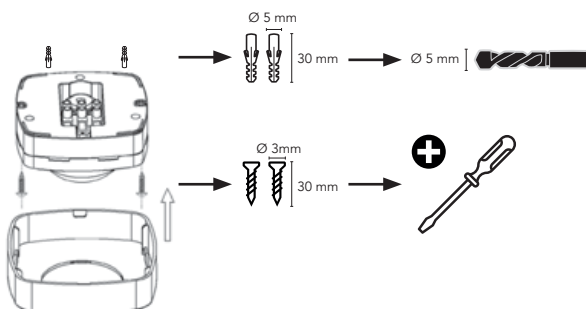

SPECIFICATIONS

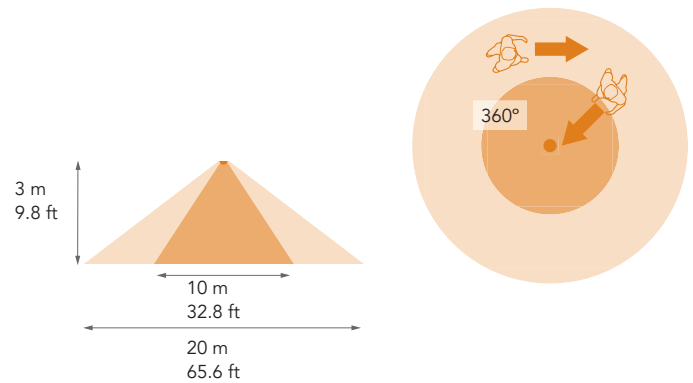

FEATURES

Angle of coverage	360°
Area of coverage	20 m diameter (at 3 m height)
Adjustment twilight	3 - 2000 lux
Contact capacity	Incandescence: 2000W Energy saving lamps: 1000W LED lamps: 1000W
Protection degree	IP65
Supply voltage	220-240VAC 50/60Hz

PACKAGING & LOGISTICS INFORMATION

HS Code: 85365080

Carton box

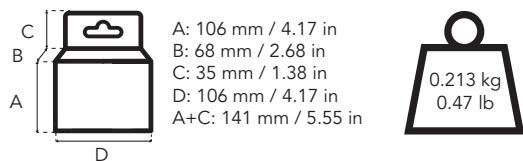

Export carton

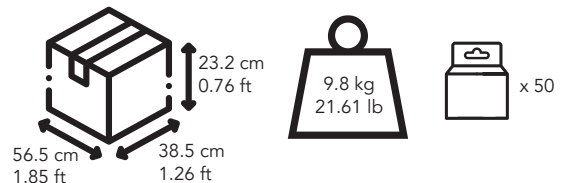

Pallet

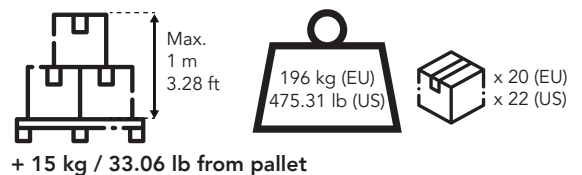



- Downlight format for installations in false ceilings.
- 360° Detection coverage.
- Easy and fast to setup up and install.

ZCS TECHNOLOGY
Zero Cross Switching



C-LOGIC 635-MD

False ceiling movement detector
Item Code: CLOGIC635MD230VCBINT
Prev. Code: 301000026
EAN Code: 8435394748078



More info

CONTENTS



MAIN APPLICATIONS

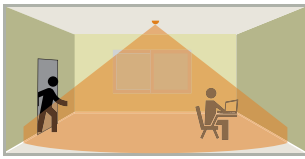

CONNECTION GUIDE

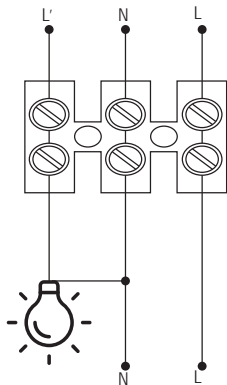

DIMENSIONS

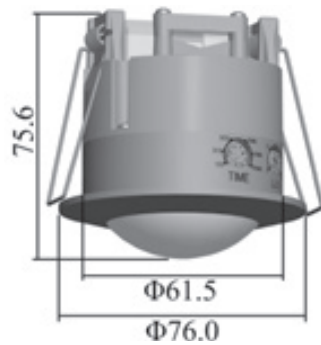

INSTALLATION

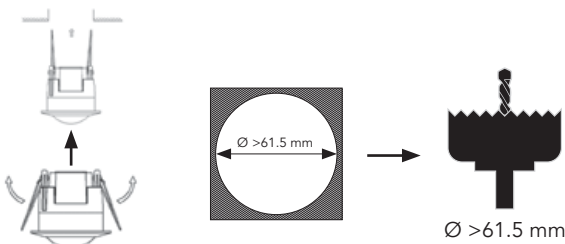

SPECIFICATIONS

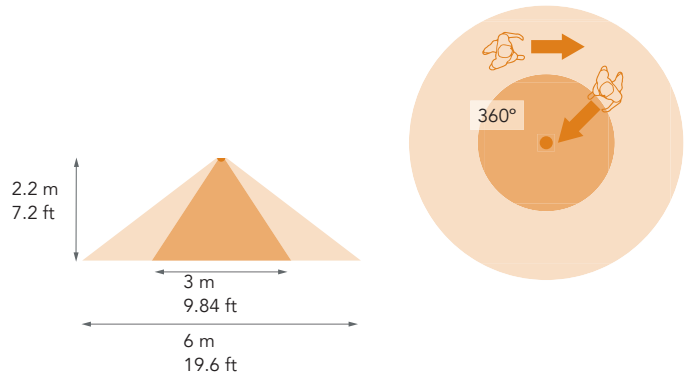

FEATURES

Angle of coverage	360°
Area of coverage	6 m diameter (at 2.2 m height)
Adjustment twilight	3 - 2000 lux
Contact capacity	Incandescence: 1200W Energy saving lamps: 300W LED lamps: 300W
Supply voltage	220-240VAC 50/60Hz

PACKAGING & LOGISTICS INFORMATION

HS Code: 85365080

Carton box

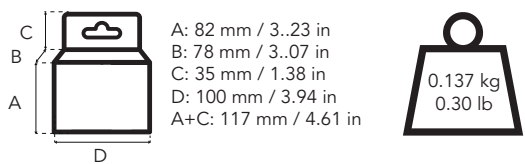

Export carton

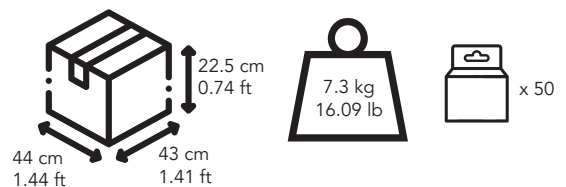

Pallet

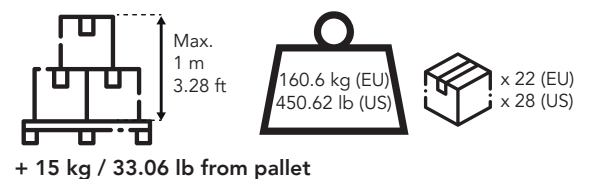



- False ceiling mini movement detector utmost discretion.
- Head of just 5 cm diameter.
- Externally accessible potentiometer behind the external ring.

ZCS TECHNOLOGY
Zero Cross Switching



C-LOGIC 640-MD

False ceiling mini movement detector
Item Code: CLOGIC640MD230VCBINT
Prev. Code: 301000027
EAN Code: 8435394748085



More info

CONTENTS



MAIN APPLICATIONS

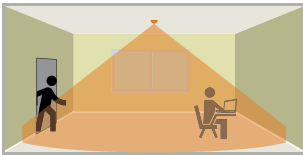

CONNECTION GUIDE

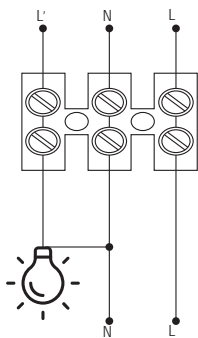

DIMENSIONS

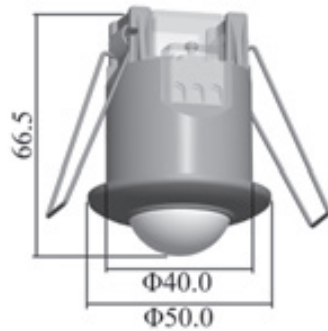

INSTALLATION

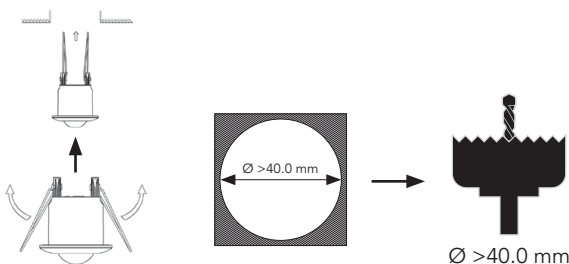

SPECIFICATIONS

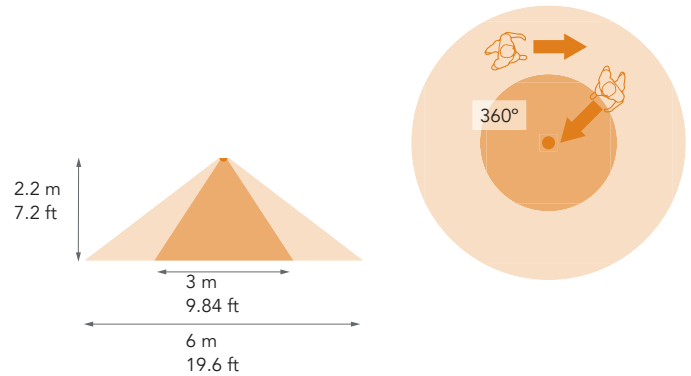

FEATURES

Angle of coverage	360°
Area of coverage	6 m diameter (at 2.2 m height)
Adjustment twilight	3 - 2000 lux
Contact capacity	Incandescence: 800W Energy saving lamps: 400W LED lamps: 400W
Supply voltage	220-240VAC 50/60Hz

PACKAGING & LOGISTICS INFORMATION

HS Code: 85365080

Carton box

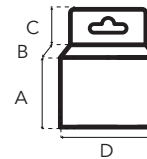

A: 71 mm / 2.80 in
B: 61 mm / 2.40 in
C: 30 mm / 1.18 in
D: 78 mm / 3.07 in
A+C: 101 mm / 3.98 in



Export carton

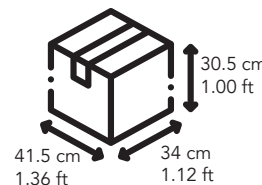

Pallet

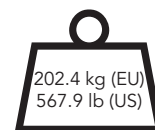
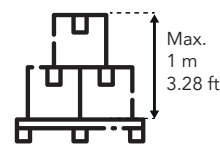

+ 15 kg / 33.06 lb from pallet



- 2 or 3 wire connection perfect for renovations.
- Manual ON / OFF / AUTO switch.
- The potentiometer and switch remain hidden behind the protective cover to avoid any tampering.

ZCS TECHNOLOGY
Zero Cross Switching



C-LOGIC 645-MD

Movement detector for wiring devices boxes
Item Code: CLOGIC645MD230VCBINT
Prev. Code: 301000030
EAN Code: 8435394748115



More info

CONTENTS



MAIN APPLICATIONS

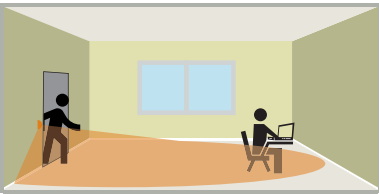

CONNECTION GUIDE

2 wires

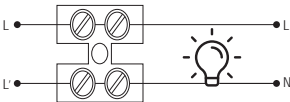

3 wires

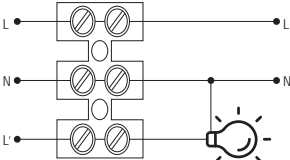

DIMENSIONS

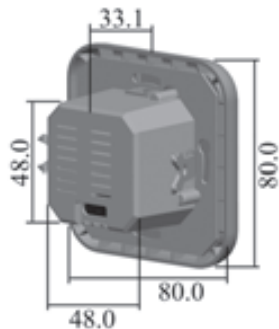

INSTALLATION

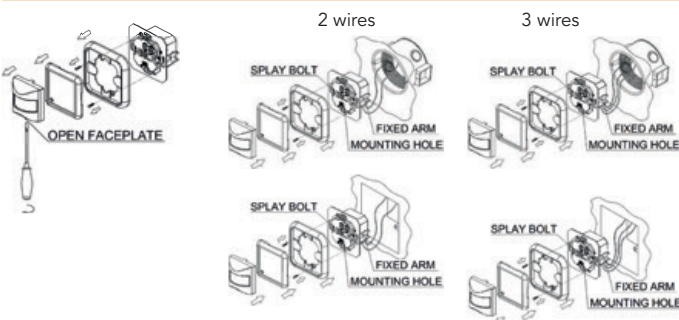

SPECIFICATIONS

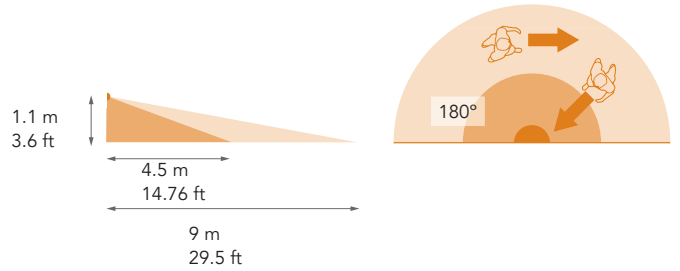

FEATURES

Angle of coverage	180°
Area of coverage	9 m diameter (at 1.1 m height)
Adjustment twilight	3 - 2000 lux
Contact capacity	Incandescence: 500W Energy saving lamps: 200W LED lamps: 200W
Minimum power required	5W to 2 wires
Supply voltage	220-240VAC 50/60Hz

PACKAGING & LOGISTICS INFORMATION

HS Code: 85365080

Carton box

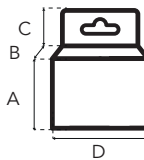

A: 85 mm / 3.35 in
B: 71 mm / 2.80 in
C: 35 mm / 1.38 in
D: 83 mm / 3.27 in
A+C: 120 mm / 4.72 in



Export carton

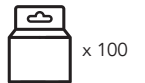
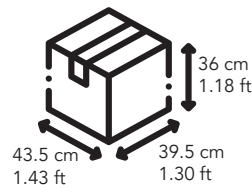

Pallet

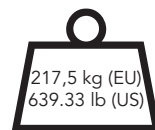
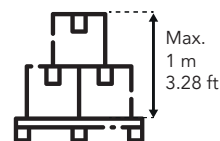

+ 15 kg / 33.06 lb from pallet



- It detects through surfaces allowing you to install the product above false ceilings remaining hidden
- 5.8 GHz high frequency technology
- Great coverage of up to 16 m in diameter (adjustable from 2 to 16m).



C-LOGIC 650-MD

Movement detector hidden in false ceiling
 Item Code: CLOGIC650MD230VCBINT
 Prev. Code: 301000029
 EAN Code: 8435394748108



More info

SPECIFICATIONS

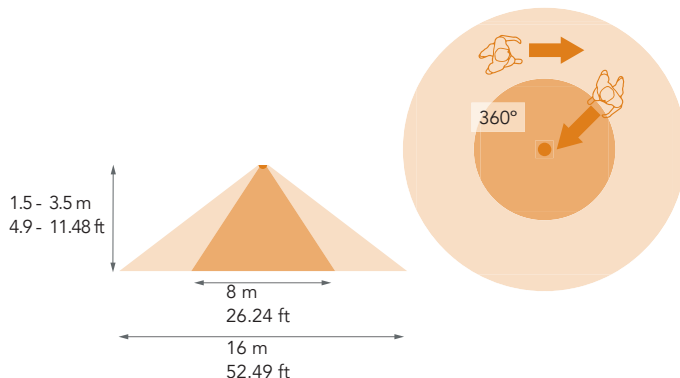

FEATURES

Angle of coverage	360°
Area of coverage	16 m diameter (at 2.2m height)
Adjustment twilight	3 - 2000 lux
Contact capacity	Incandescence: 1200W Energy saving lamps: 300W LED lamps: 300W
Supply voltage	220-240VAC 50/60Hz

PACKAGING & LOGISTICS INFORMATION

HS Code: 85311030

Carton box

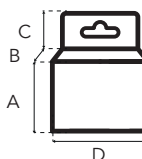

A: 74 mm / 2.91 in
 B: 50 mm / 1.97 in
 C: 30 mm / 1.18 in
 D: 51 mm / 2.01 in
 A+C: 104 mm / 4.09 in



Export carton

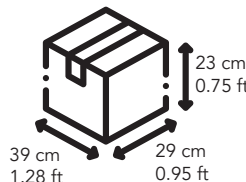

Pallet

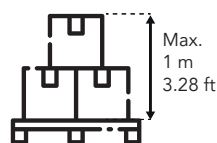

+ 15 kg / 33.06 lb from pallet

CONTENTS

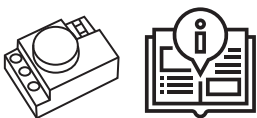

MAIN APPLICATIONS

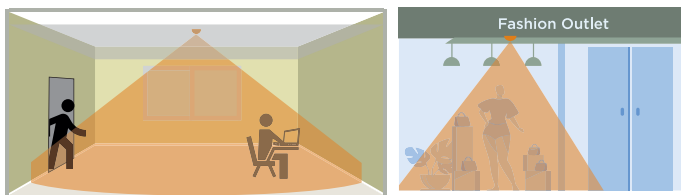

CONNECTION GUIDE

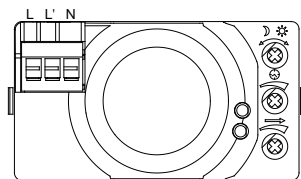

Connect . L with power; Connect . L' with load.

DIMENSIONS

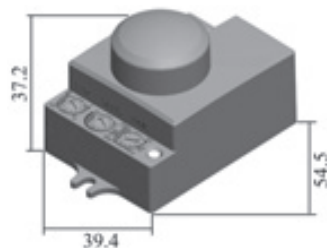

INSTALLATION

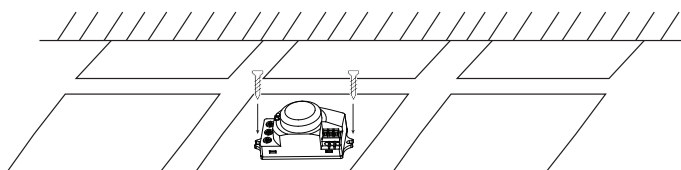



- 360° coverage area.
- Max. range 6m diameter.
- Twilight adjustment: 3 to 2.000 lux.
- Time adjustment: 10 seconds to 5 minutes.
- Maximum contact capacity: 60W (E27).

C-LOGIC 655-MD

Lampholder with integrated detector
 Item Code: CLOGIC655MD230VCBINT
 Prev. Code: 301000134
 EAN Code: 8435394777559
 UPC Code: 810053671870



CONTENTS



MAIN APPLICATIONS

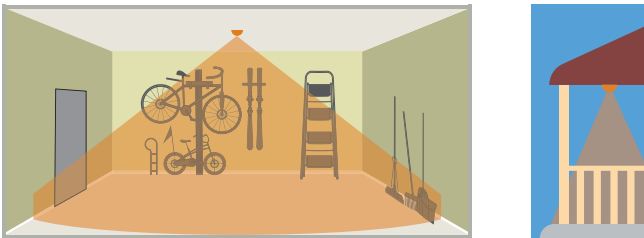

CONNECTION GUIDE



DIMENSIONS

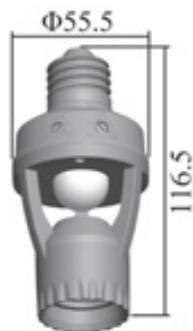

SPECIFICATIONS

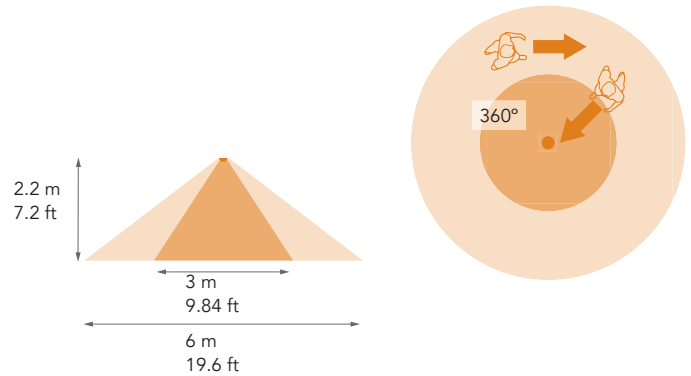

FEATURES

Angle of coverage	360°
Area of coverage	6 m diameter
Adjustment twilight	3 - 2000 lux
Contact capacity	Incandescence: 60W Energy saving lamps: 60W LED lamps: 60W
Supply voltage	110-240V. 50Hz

PACKAGING & LOGISTICS INFORMATION

HS Code: 85414080

Carton box

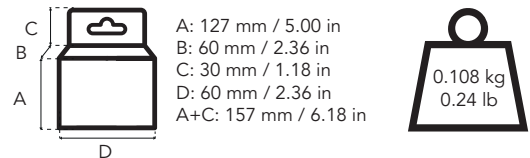

Export carton

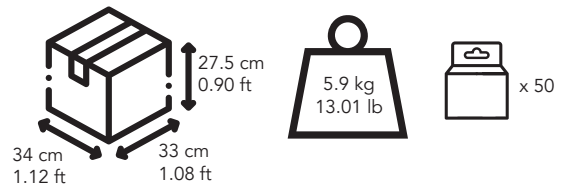

Pallet

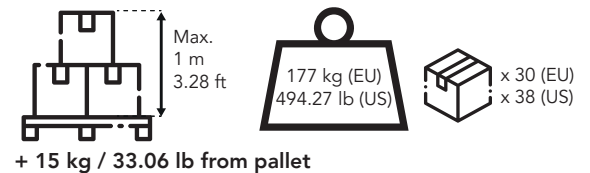



- False ceiling micro movement detector head of just 2 cm diameter.
- For installation in false ceilings interior of closet, etc.
- Time and lux adjustment.



C-LOGIC 660-MD

Surface / pole twilight detector
 Item Code: CLOGIC660MD230VCBINT
 Prev. Code: 301000028
 EAN Code: 8435394748092



CONTENTS

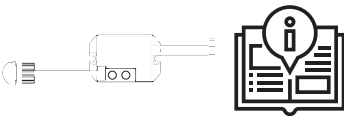

MAIN APPLICATIONS

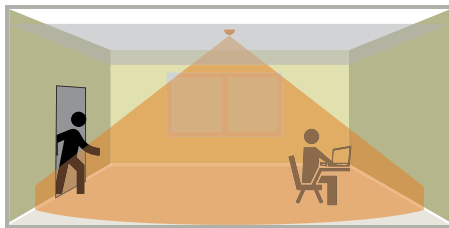

CONNECTION GUIDE

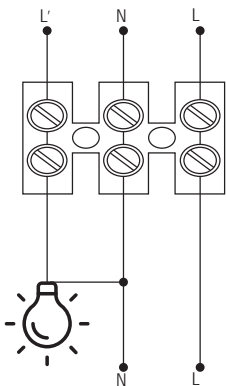

DIMENSIONS

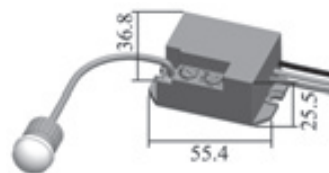

INSTALLATION

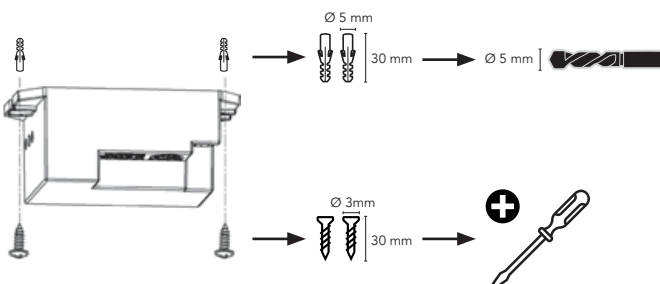

SPECIFICATIONS

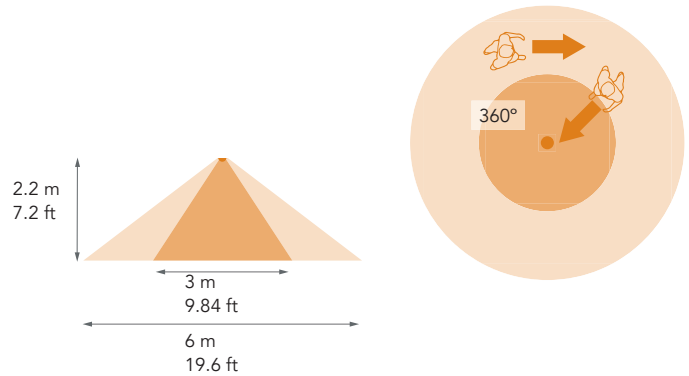

FEATURES

Angle of coverage	Ceiling: 360° Wall: 120°
Area of coverage	Ceiling: 6 m diameter (at 2.2 m height) Wall: 8 m
Adjustment twilight	3 - 2000 lux
Contact capacity	Incandescence: 800W Energy saving lamps: 200W LED lamps: 200W
Supply voltage	220-240VAC 50-60Hz

PACKAGING & LOGISTICS INFORMATION

HS Code: 85365080

Carton box

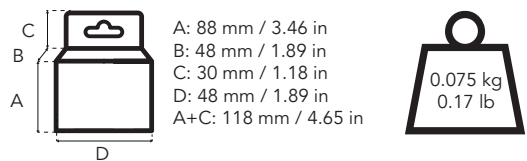

Export carton

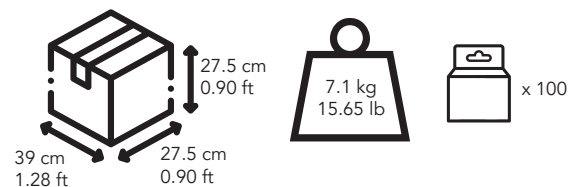

Pallet

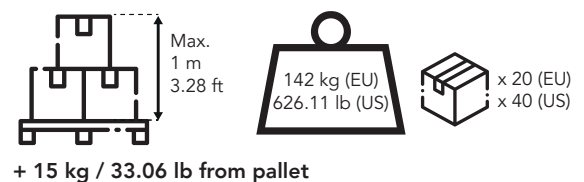



- Supply: 1 x 9V battery (included)
- 60° coverage area
- Max. range of 8 m
- Alarm sound: ≥ 70 dB
- 3 positions:
 - Chime: ring function
 - Alarm
 - OFF



C-LOGIC 600-MD

Mini sensor alarm with integrated presence detector
 Item Code: CLOGIC600MDCBINT
 Prev. Code: 301000032
 EAN Code: 8435394748139
 UPC Code: 810053671313



More info

CONTENTS



MAIN APPLICATIONS

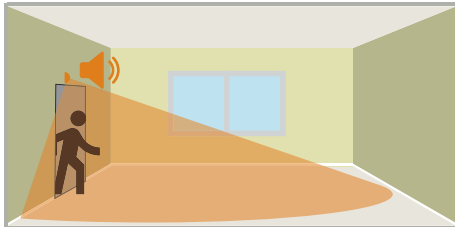

CONNECTION GUIDE

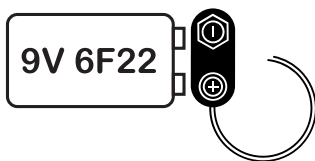

DIMENSIONS

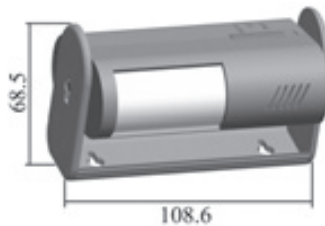

INSTALLATION

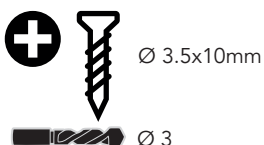
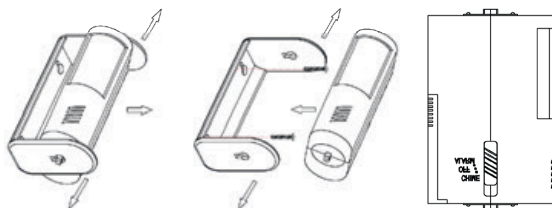

SPECIFICATIONS

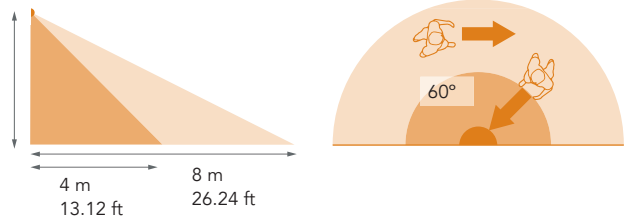

FEATURES

Angle of coverage	60°
Max. area of coverage	8 m
Sound level	≥ 70 dB
Supply voltage	1 x 9V battery included

PACKAGING & LOGISTICS INFORMATION

HS Code: 85365080

Carton box

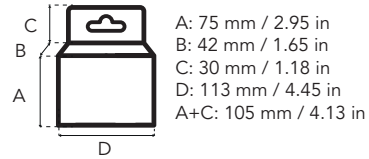

A: 75 mm / 2.95 in
 B: 42 mm / 1.65 in
 C: 30 mm / 1.18 in
 D: 113 mm / 4.45 in
 A+C: 105 mm / 4.13 in



Export carton

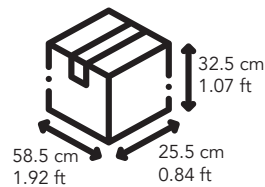

Pallet

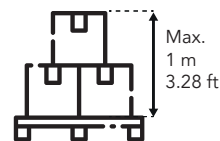

+ 15 kg / 33.06 lb from pallet



- High frequency RADAR detection 5.8GHz.
- E27 lamp holder suitable for all types of lamps.
- Glass lampshade polycarbonate base material.
- Additional terminal for secondary load control.

C-LOGIC 665-MD

RADAR sensor light

Item Code: CLOGIC665MD230VCBINT

Prev. Code: 301000090

EAN Code: 8435394776989



More info

CONTENTS



MAIN APPLICATIONS

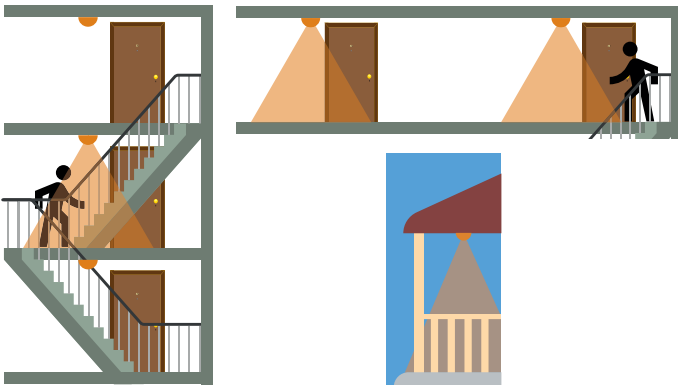

CONNECTION GUIDE

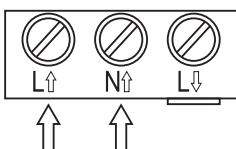

DIMENSIONS

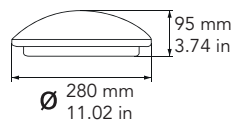

INSTALLATION

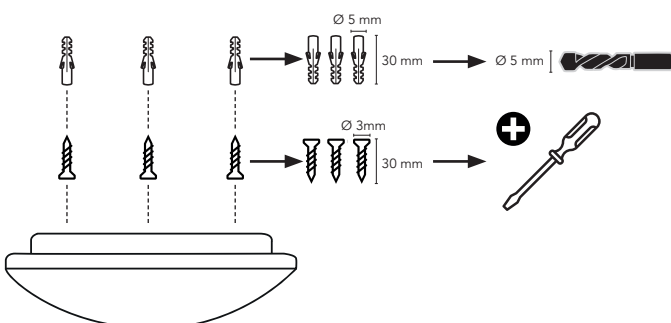

SPECIFICATIONS

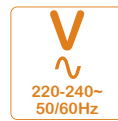
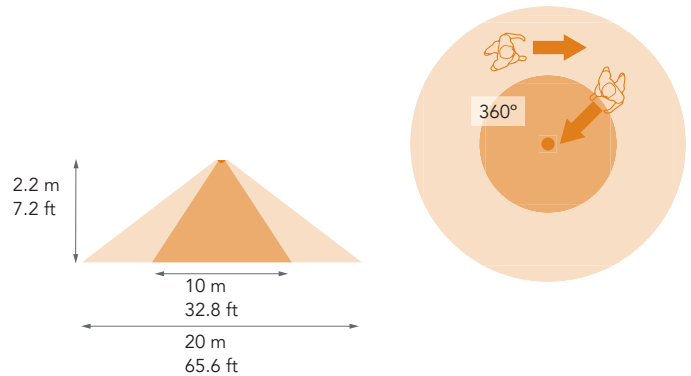

FEATURES

Angle of coverage	360°
Area of coverage	20 m diameter
Adjustment twilight	2 - 2000 lux
Additional output	300W capacity.
Max contact capacity	Incandescence: 60W Energy saving lamps: 13W (max.) LED lamps: <20W
Supply voltage	220-240VAC 50-60Hz

PACKAGING & LOGISTICS INFORMATION

HS Code: 94051098

Carton box

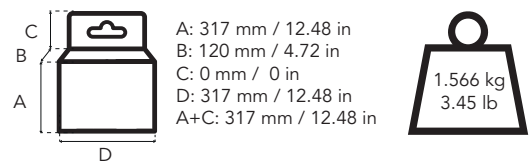

Export carton

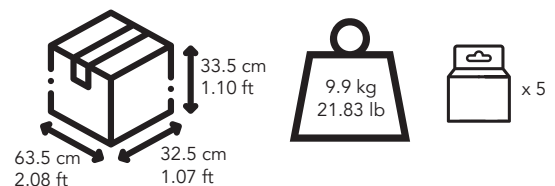

Pallet





- 2 Lamp holders E27 suitable for all types of lamps.
- Glass lampshade white aluminium base Polycarbonate lampshade.
- The wide curvature of the dome light allows the installation of large lamps.

C-LOGIC 670-MD

PIR sensor light with built-in LED
 Item Code: CLOGIC670MD230VCBINT
 Prev. Code: 301000091
 EAN Code: 8435394776996



More info

CONTENTS



MAIN APPLICATIONS

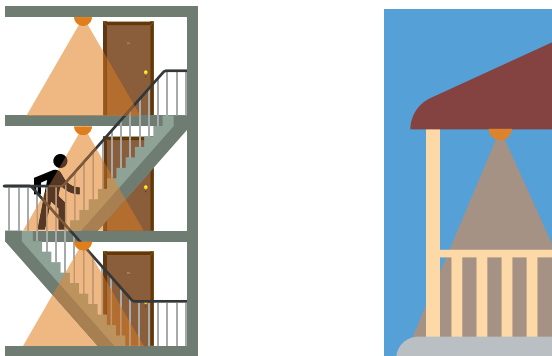

CONNECTION GUIDE

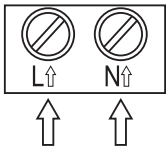

DIMENSIONS

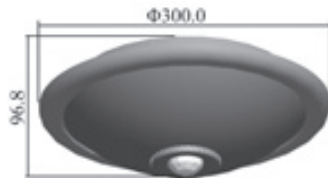

INSTALLATION

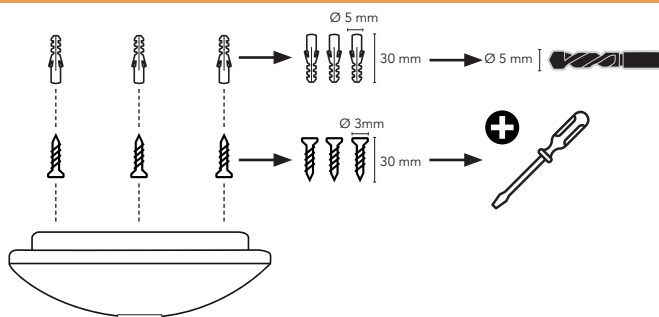

SPECIFICATIONS

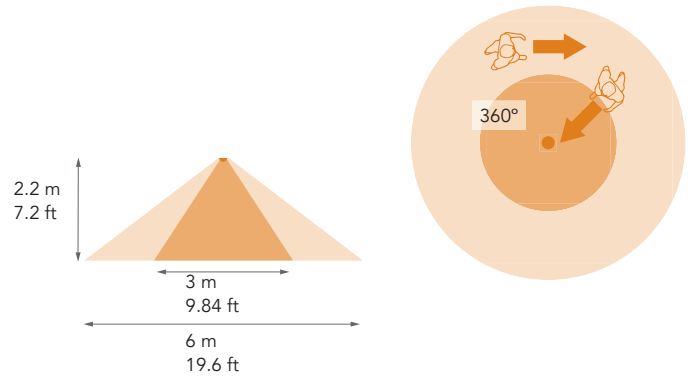

FEATURES

Angle of coverage	360°
Area of coverage	6 m diameter (at 2.2 m height)
Adjustment twilight	3 - 2000 lux
Contact capacity	2x40W
Supply voltage	110-240VAC 50/60Hz

PACKAGING & LOGISTICS INFORMATION

HS Code: 94051098

Carton box

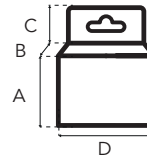

A: 303 mm / 11.93 in
 B: 97 mm / 3.82 in
 C: 0 mm / 0 in
 D: 305 mm / 12.01 in
 A+C: 303 mm / 11.93 in



Export carton

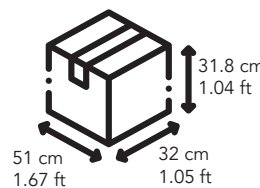

Pallet

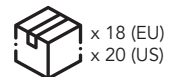
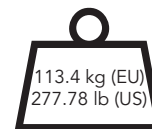
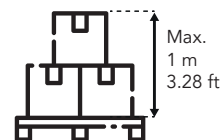

+ 15 kg / 33.06 lb from pallet



- High Frequency RADAR detection with built-in LED board.
- Plastic lampshade white aluminium base glass lampshade.
- Neutral white light suitable for commercial environments and common areas in buildings.

C-LOGIC 675-MD

RADAR sensor light
 Item Code: CLOGIC840UKDC230VCBINT
 Prev. Code: 301000092
 EAN Code: 8435394777009

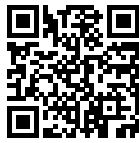

More info

CONTENTS

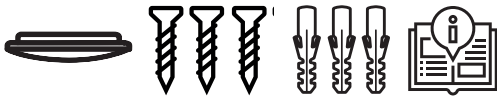

MAIN APPLICATIONS

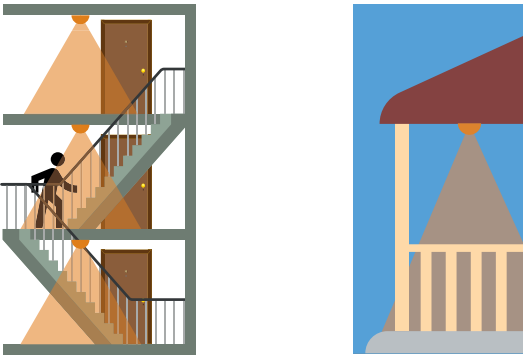

CONNECTION GUIDE

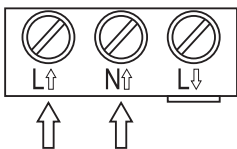

DIMENSIONS

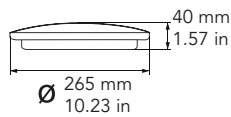

INSTALLATION

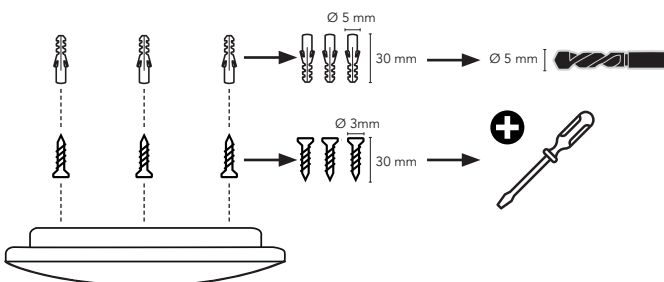

SPECIFICATIONS

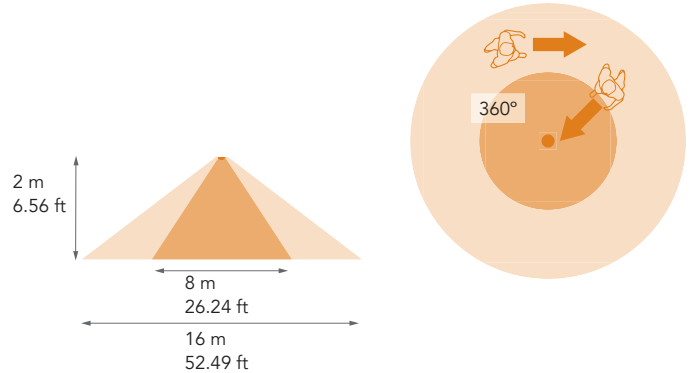

220-240~50/60Hz	3-2000 Lux	10s - 12min	IP 54	OK LED
-----------------	------------	-------------	-------	--------

FEATURES

Angle of coverage	360°
Area of coverage	18 m diameter
Adjustment twilight	3 - 2000 lux
Max contact capacity	16W built-in LED. 1300 lumens. 4000K
Supply voltage	220-240VAC 50-60Hz

PACKAGING & LOGISTICS INFORMATION

HS Code: 94051098

Carton box

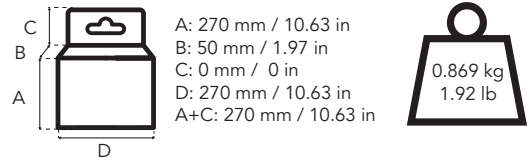

Export carton

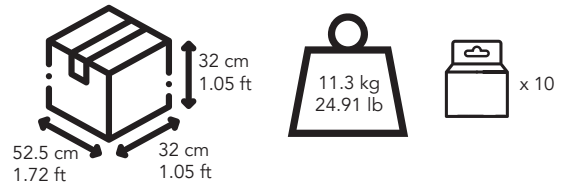

Pallet

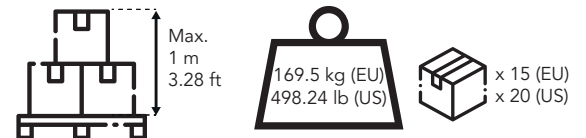

+ 15 kg / 33.06 lb from pallet



- High Frequency PIR detection with built-in LED board
- Plastic lampshade white aluminium base
- 16W integrated LED
- Luminous flux of 1.100 lumens
- Color temperature: 4.000K

C-LOGIC 680-MD

PIR sensor light with built-in LED
 Item Code: CLOGIC680MDDUALCBINT
 Prev. Code: 301000093
 EAN Code: 8435394777016
 UPC Code: 810053671610

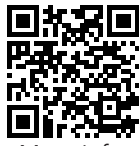

More info

CONTENTS

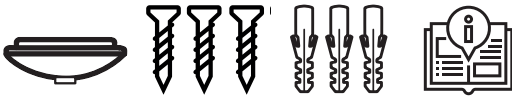

MAIN APPLICATIONS



CONNECTION GUIDE

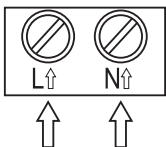

DIMENSIONS

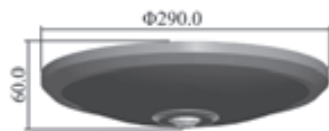

INSTALLATION

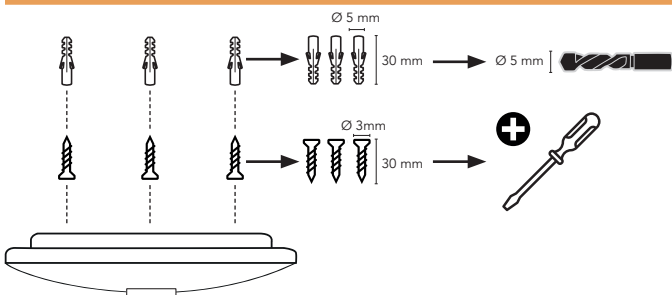

SPECIFICATIONS

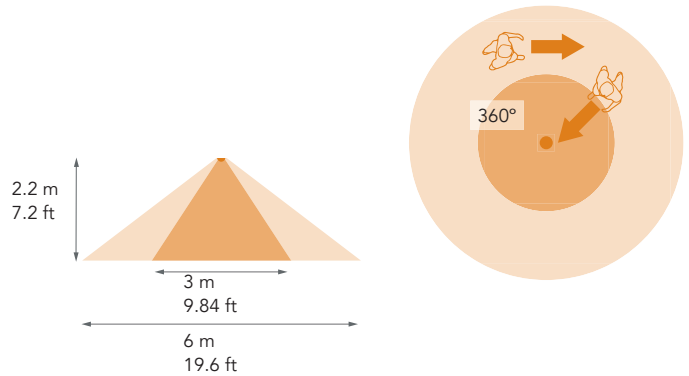

FEATURES

Angle of coverage	360°
Area of coverage	6 m diameter (at 2.2 m height)
Adjustment twilight	3 - 2000 lux
Contact capacity	16W built-in LED. 1100 lumens. 4000K
Supply voltage	110-240VAC 50/60Hz

PACKAGING & LOGISTICS INFORMATION

HS Code: 94051098

Carton box

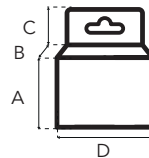

A: 295 mm / 11.61 in
 B: 64 mm / 2.52 in
 C: 0 mm / 0 in
 D: 295 mm / 11.61 in
 A+C: 295 mm / 11.61 in



Export carton

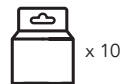
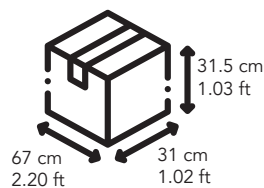

Pallet

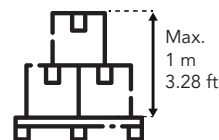

+ 15 kg / 33.06 lb from pallet



- PIR technology with integrated LED.
- Material:PC(UV proof)

ZCS TECHNOLOGY
Zero Cross Switching



C-LOGIC 685-MD

PIR sensor light with built-in LED
Item Code: CLOGIC685MDDUALCBINT
Prev. Code: 301000094
EAN Code: 8435394777023
UPC Code: 810053671627



More info

CONTENTS



MAIN APPLICATIONS

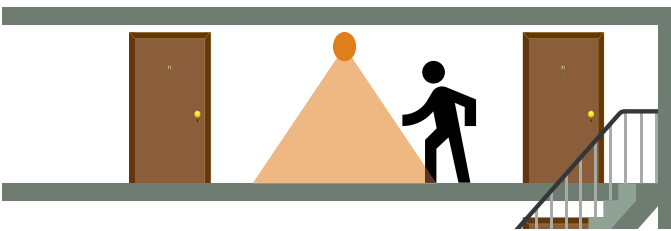

CONNECTION GUIDE

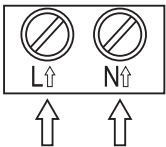

DIMENSIONS

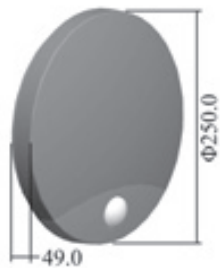

INSTALLATION

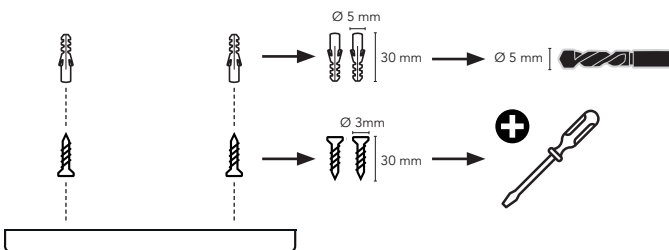

SPECIFICATIONS

Wall installation

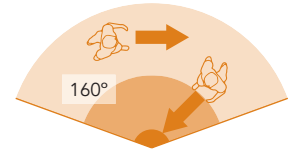
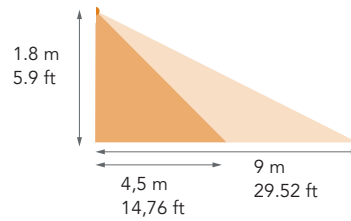

Ceiling installation

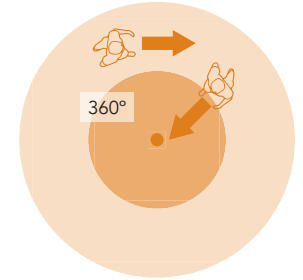
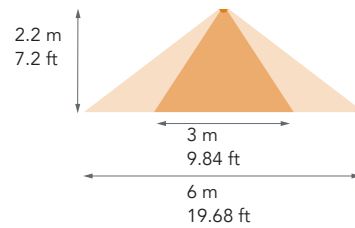

FEATURES

Angle of coverage	160° (wall) - 360°(ceiling)
Area of coverage	9 m (wall) - 6 m (ceiling)
Adjustment twilight	3 - 2000 lux
Rated Load	15W
Supply voltage	110-240V; 50-60Hz

PACKAGING & LOGISTICS INFORMATION

HS Code: 94051098

Check available packaging options.



- For wall mounting.
- Suitable for outdoor applications.
- Twilight setting from 2 to 100 lux.
- Security timing of 1 min in on and off to prevent false switching

C-LOGIC 515-PC

Wall twilight switch IP44
 Item Code: CLOGIC515PC230VCBINT
 Prev. Code: 301000095
 EAN Code: 8435394777030



More info

CONTENTS



MAIN APPLICATIONS

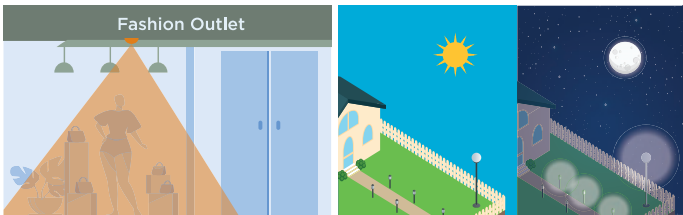

CONNECTION GUIDE

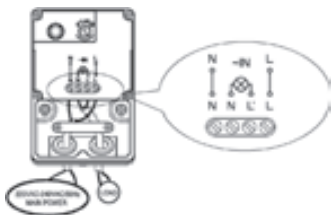

DIMENSIONS

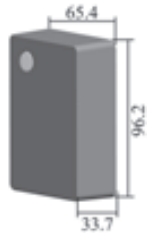

INSTALLATION

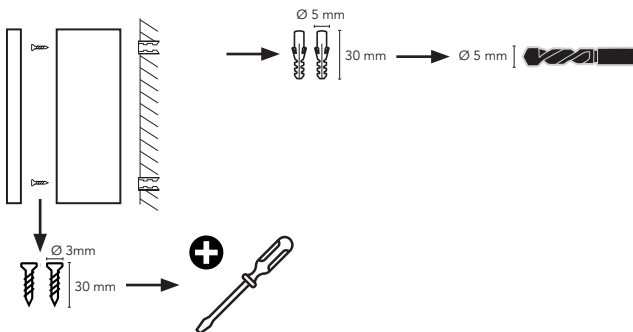

SPECIFICATIONS



FEATURES

Security timing of 1 min in on and off to prevent false switching

Adjustment LED

According to EN 60669-1:1999+A1:2002+A2:200.
 EN 60669-2-1:2004+A1:2009+A12:2010

PACKAGING & LOGISTICS INFORMATION

HS Code: 85311030

Carton box

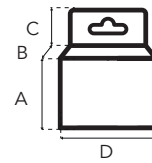

A: 105 mm / 4.13 in
 B: 43 mm / 1.69 in
 C: 30 mm / 1.18 in
 D: 72 mm / 2.83 in
 A+C: 135 mm / 5.31 in



Export carton

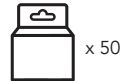
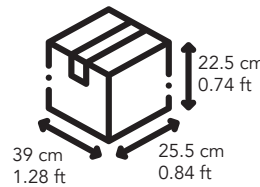

Pallet

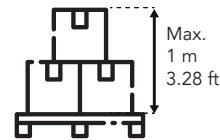

+ 15 kg / 33.06 lb from pallet



- For wall mounting.
- Suitable for outdoor applications.
- Twilight setting from 3 to 500 lux.
- Security timing of 1 min in on and off to prevent false switching

C-LOGIC 510-PC

Wall twilight switch IP54
 Item Code: CLOGIC510PC230VCBINT
 Prev. Code: 301000031
 EAN Code: 8435394748122



More info

CONTENTS



MAIN APPLICATIONS

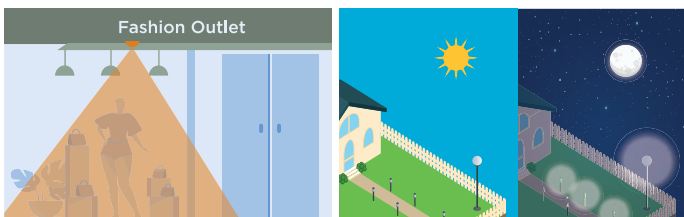

CONNECTION GUIDE

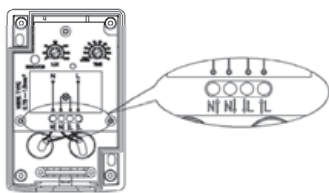

DIMENSIONS



INSTALLATION

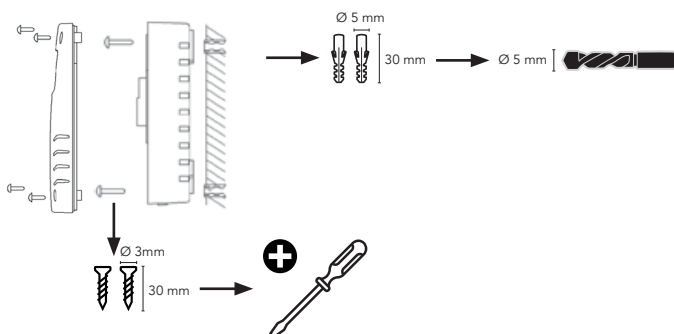

SPECIFICATIONS



FEATURES

Security timing of 1 min in on and off to prevent false switching

Adjustment LED

Optional switching OFF timing for 1 to 9 hours from the moment it is activated

According to EN 60669-1:1999+A1:2002+A2:200.
 EN 60669-2-1:2004+A1:2009+A12:2010

PACKAGING & LOGISTICS INFORMATION

HS Code: 85311030

Carton box

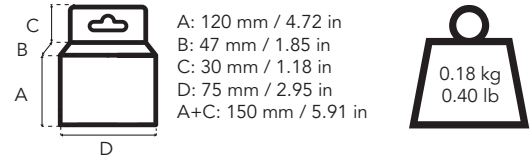

Export carton

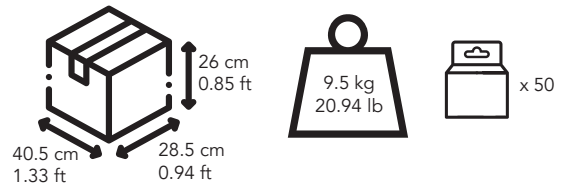

Pallet

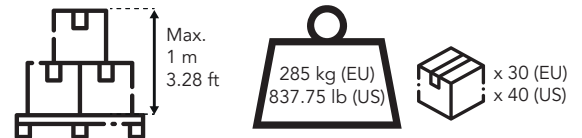

+ 15 kg / 33.06 lb from pallet



- Twist and lock NEMA standard
- MOV built-in for lightning protection
- Time delay to avoid false switchings
- Fail ON or fail OFF modes



C-LOGIC 500-PC

Mechanical photocell
 Item Code: CLOGIC500PC230VCBINT
 Prev. Code: 301000077
 EAN Code: 8435394776774
 UPC Code: 810053670934



More info

CONTENTS



MAIN APPLICATIONS

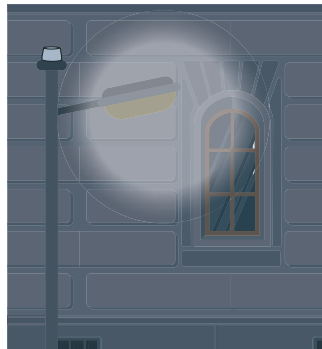
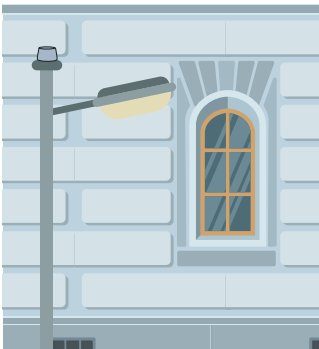

CONNECTION GUIDE

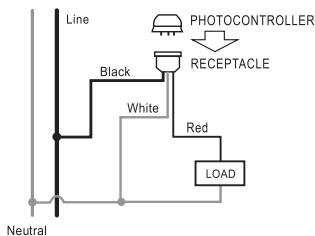

DIMENSIONS

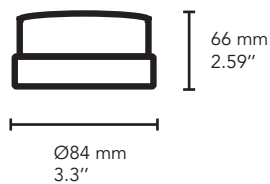

INSTALLATION

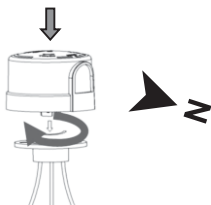

SPECIFICATIONS



FEATURES

Rated Voltage	220-240V~,50/60Hz
Rated Loading	1800W Tungsten, 1000VA Ballast
Power consumption	1.5VA (average)
Delay Time	30 sec.

General

Surge arrester	•
Ambient Temperature	-40°C/70°C (-40°F/158°F)
Related Humidity	99%
Protection degree	IP54
Certifications	UL

PACKAGING & LOGISTICS INFORMATION

HS Code: 85414001

Check available packaging options.



- Twist and lock NEMA standard
- MOV built-in for lightning protection
- Time delay to avoid false switchings
- Fail ON or fail OFF modes



C-LOGIC 501-PC

Electronic photocell
 Item Code: CLOGIC501PCDUALCBINT
 Prev. Code: 301000078
 EAN Code: 8435394776781
 UPC Code: 810053670958

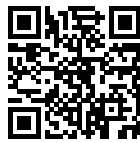

More info

CONTENTS



MAIN APPLICATIONS

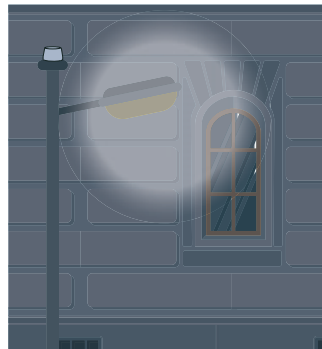

CONNECTION GUIDE

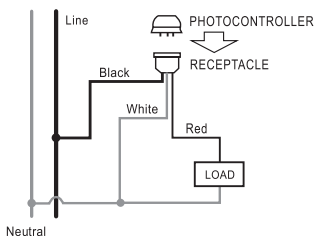

DIMENSIONS

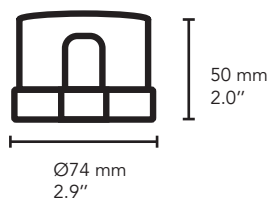

INSTALLATION

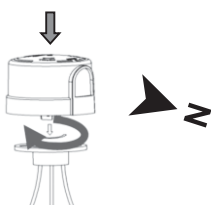

SPECIFICATIONS

120-277V~50/60Hz	10-20 Lux / 30-60 Lux	10-30 sec	IP 54	SURGE PROTECTION
------------------	-----------------------	-----------	-------	------------------



FEATURES

Rated Voltage	120-277V~,50/60Hz
Rated Loading	1000W Tungsten, 1800VA Ballast
Power consumption	1.5VA (average)
Delay Time	30 sec.

General

Surge arrester	•
Ambient Temperature	-40°C/70°C (-40°F/158°F)
Related Humidity	99%
Protection degree	IP54
Certifications	UL

PACKAGING & LOGISTICS INFORMATION

HS Code: 85414001

Check available packaging options.



- Twist and lock NEMA standard
- Designed to fit ANSI C136.10-1996 twist-lock photocontrol



C-LOGIC 502-PC

Photocell base
 Item Code: CLOGIC502PC480VCBINT
 Prev. Code: 301000079
 EAN Code: 8435394776798
 UPC Code: 810053670972



More info

SPECIFICATIONS



FEATURES

Rated Voltage	480V~,50/60Hz
Loading capacity	15Amp Maz.

General

Ambient Temperature	-40°C/70°C (-40°F/158°F)
Related Humidity	99%
Receptacle material	Bakelite
Contact material	Brass
Gasket	Silicon rubber
Certifications	UL

PACKAGING & LOGISTICS INFORMATION

HS Code: 85414019

Check available packaging options.

CONTENTS



MAIN APPLICATIONS

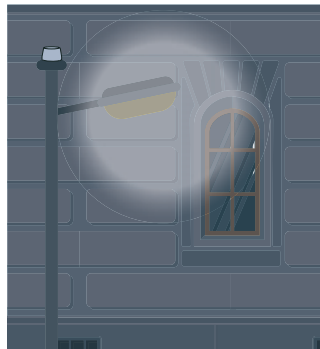
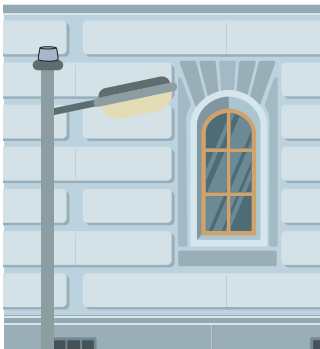

CONNECTION GUIDE

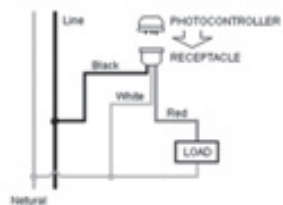

DIMENSIONS

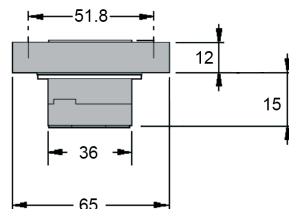

INSTALLATION

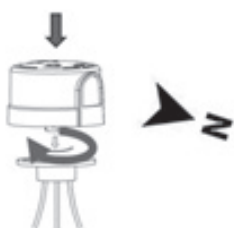



- Suitable for Surface/pole mounting
- Rated loading: 20 Amps



C-LOGIC 520-PC

Electromechanical Photocontroller
 Item Code: CLOGIC520PC230VCBINT
 Prev. Code: 301000096
 EAN Code: 8435394777047



More info

CONTENTS



MAIN APPLICATIONS

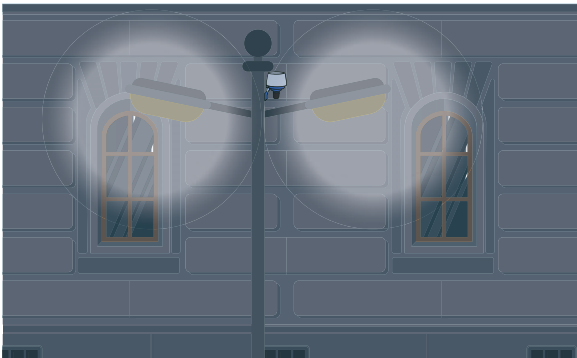

CONNECTION GUIDE

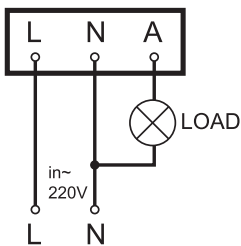

DIMENSIONS

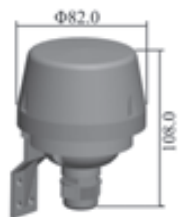

INSTALLATION

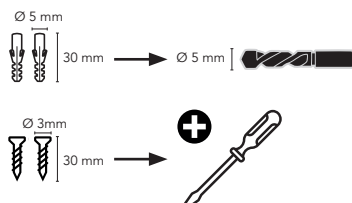

SPECIFICATIONS



FEATURES

Rated Voltage	220-240V~,50/60Hz
Rated Loading	20A
Power consumption	1.5VA (average)
Lux control	<5-50Lux (adjustable)

General

Ambient Temperature	20°C/+40°C
Related Humidity	93%
Protection degree	IP44
Certifications	CE,ROHS

PACKAGING & LOGISTICS INFORMATION

HS Code: 85318040

Check available packaging options.



- Electromechanical buzzer
- Power supply: 230VAC 50-60Hz
- 2-wire connection
- Compact size
- Installation using 1 fixing screw
- High sound level

C-LOGIC 800-DC

Electromechanical buzzer
 Item Code: CLOGIC800DC230VCBINT
 Prev. Code: 301000097
 EAN Code: 8435394777054

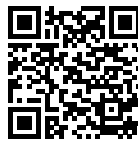

More info

CONTENTS

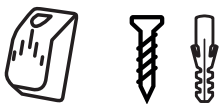

MAIN APPLICATIONS

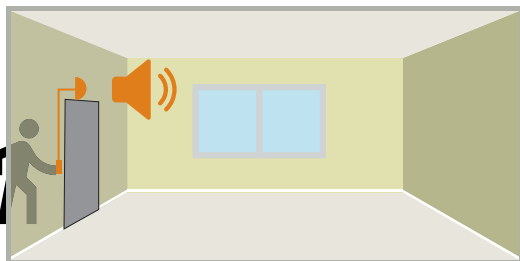

CONNECTION GUIDE

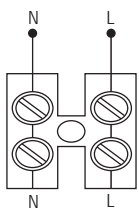

DIMENSIONS

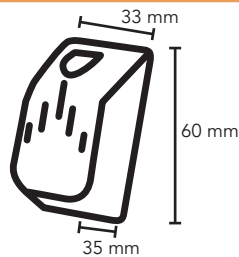

INSTALLATION

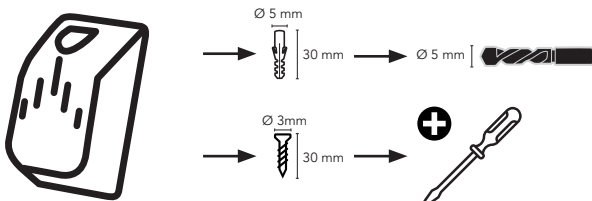

SPECIFICATIONS

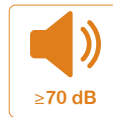

FEATURES

According to EN 62080:2009

Power supply: 230VAC 50-60Hz

2-wire connection

Compact size

Installation using 1 fixing screw

High sound level

PACKAGING & LOGISTICS INFORMATION

HS Code: 85318040

Carton box

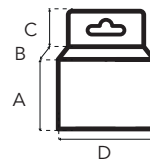

A: 60 mm / 2.36 in
 B: 40 mm / 1.57 in
 C: 0 mm / 0 in
 D: 40 mm / 1.57 in
 A+C: 60 mm / 2.36 in



Export carton

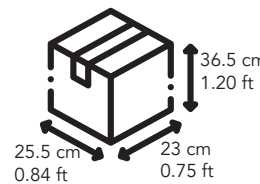

Pallet

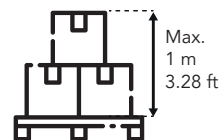

+ 15 kg / 33.06 lb from pallet



- Electromechanical ding-dong doorbell
- Power supply: 230VAC 50-60Hz
- 2-wire connection
- 10.000 turn coil that gives it a long service life
- High power and pleasant sound for home environments

C-LOGIC 810-DC

Electromechanical ding-dong doorbell
 Item Code: CLOGIC810DC230VCBINT
 Prev. Code: 301000098
 EAN Code: 8435394777061



More info

CONTENTS

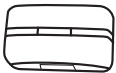

MAIN APPLICATIONS

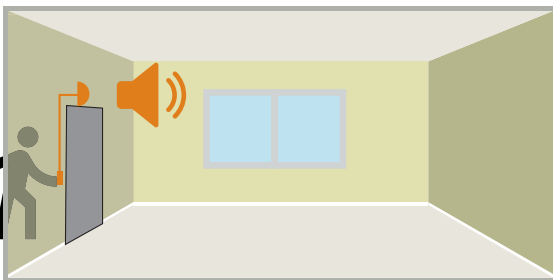

CONNECTION GUIDE

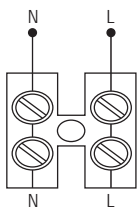

DIMENSIONS

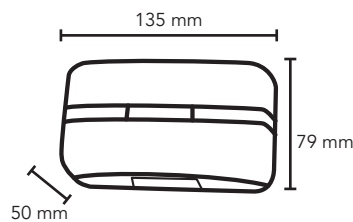

INSTALLATION

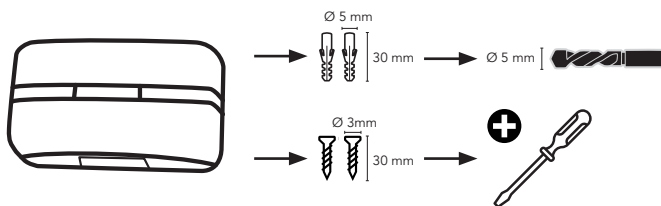

SPECIFICATIONS



FEATURES

According to EN 62080:2009

Suitable for indoor use

PACKAGING & LOGISTICS INFORMATION

HS Code: 85318040

Carton box

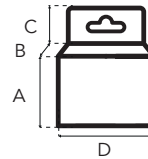

A: 140 mm / 5.51 in
 B: 50 mm / 1.97 in
 C: 45 mm / 1.77 in
 D: 85 mm / 3.35 in
 A+C: 185 mm / 7.28 in



Export carton

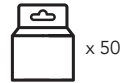
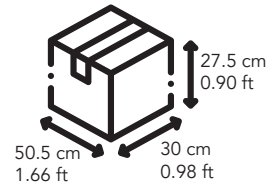

Pallet

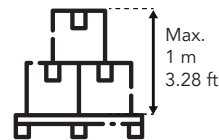

+ 15 kg / 33.06 lb from pallet



- Electronic operation
- 16 chime melodies
- Reach range of 80m between the transmitter and receiver
- Light indicator when the bell is sounding
- Transmitter with label holder

C-LOGIC 830-DC

Wireless electronic doorbell
 Item Code: CLOGIC830DCCBINT
 Prev. Code: 301000099
 EAN Code: 8435394777078
 UPC Code: 810053671634



More info

CONTENTS

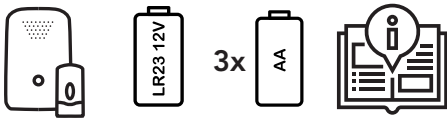

MAIN APPLICATIONS

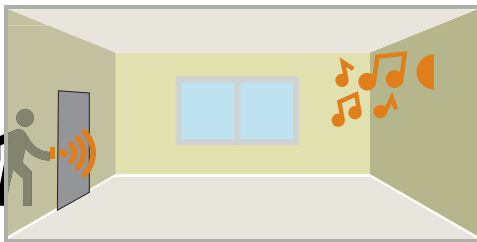

CONNECTION GUIDE

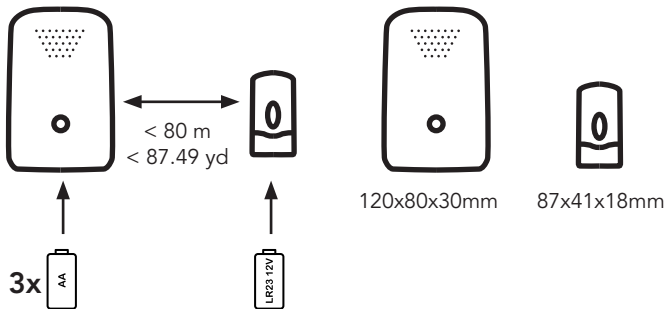

DIMENSIONS

INSTALLATION

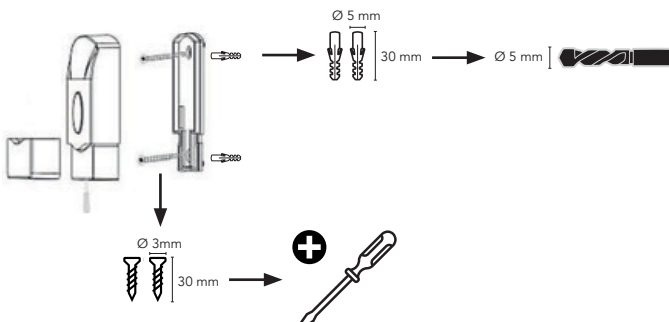

SPECIFICATIONS

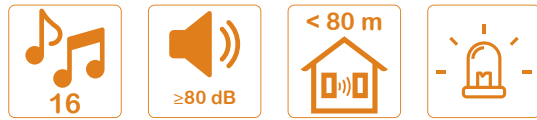

FEATURES

Possibility of personalization in the switch

Suitable for indoor use

According to EN 62080:2009

Power supply: 3x1.5AA included, 1xLR2312V included

PACKAGING & LOGISTICS INFORMATION

HS Code: 85318040

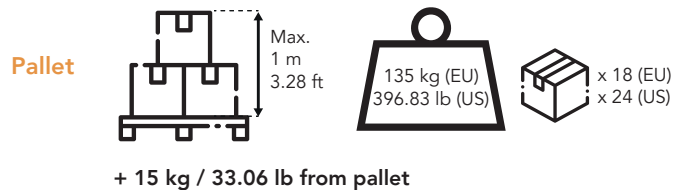
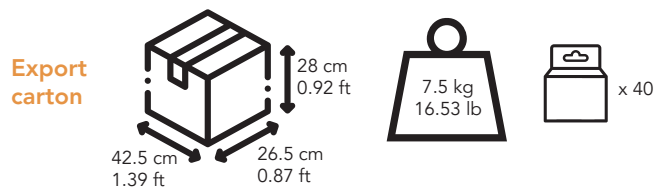
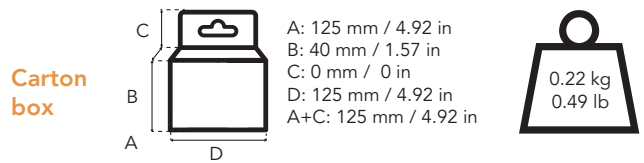



- Electronic operation
- 36 chime melodies
- Reach range of 150m between the transmitter and receiver
- Light indicator when the bell is sounding
- Transmitter with label holder
- Plug-in type



More info

C-LOGIC 840-DC

Wireless electronic doorbell

ARTICLE	840G-DC	840UK-DC
Code	CLOGIC840GDC230VCBINT	CLOGIC840UKDC230VCBINT
Prev. Code	301000100	301000101
EAN	8435394777085	8435394777092

ARTICLE	840F-DC	840I-DC
Code	CLOGIC840FDC230VCBINT	CLOGIC840IDC230VCBINT
Prev. Code	301000102	301000103
EAN	8435394777108	8435394777115

CONTENTS



MAIN APPLICATIONS

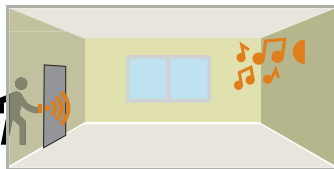

CONNECTION GUIDE

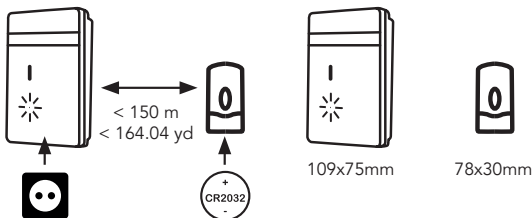

DIMENSIONS

INSTALLATION

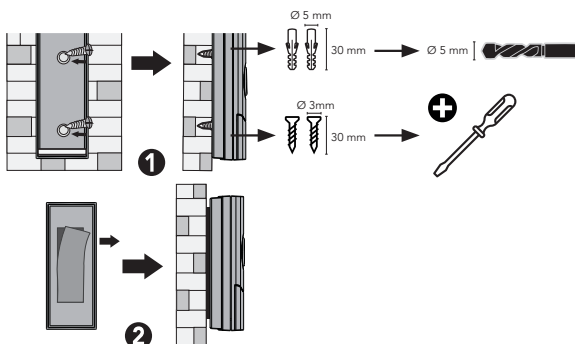

SPECIFICATIONS



FEATURES

Suitable for indoor use

Possibility of personalization in the switch

Possibility of connecting up to 5 switches to the same bell

According to EN 62080:2009

Power supply: 1xCR2032 included

PACKAGING & LOGISTICS INFORMATION

HS Code: 85318040

Carton box

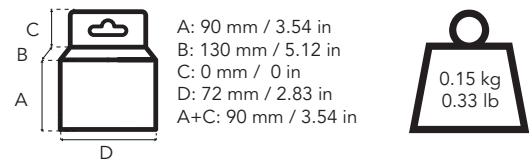

Export carton

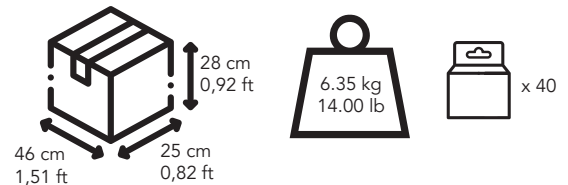

Pallet

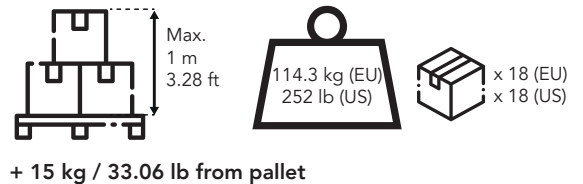



- Electronic operation
- 36 chime melodies
- Reach range of 200m between the transmitter and receiver
- Light indicator when the bell is sounding
- Transmitter with label holder

C-LOGIC 860-DC

Wireless electronic doorbell
 Item Code: CLOGIC860DCCBINT
 Prev. Code: 301000104
 EAN Code: 8435394777122
 UPC Code: 810053671641



More info

CONTENTS

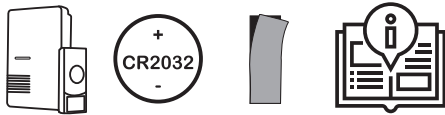

MAIN APPLICATIONS

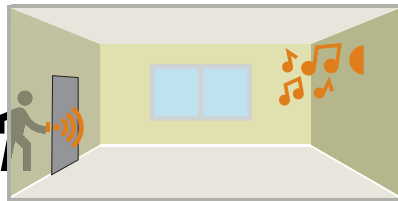

CONNECTION GUIDE

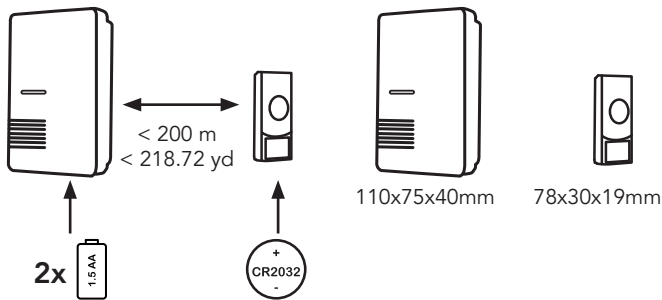

DIMENSIONS

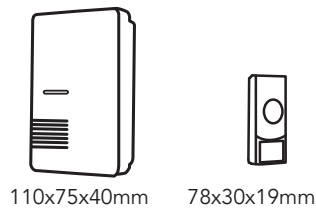

INSTALLATION

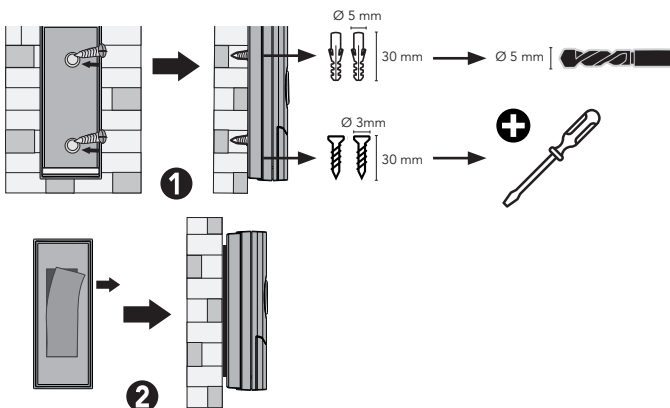

SPECIFICATIONS

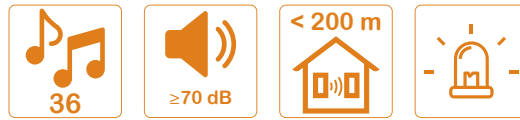

FEATURES

- Suitable for indoor use
- Possibility of personalization in the switch
- Possibility of connecting up to 5 switches to the same bell
- According to EN 62080:2009
- Power supply: 1xCR2032 included, 2x1.5AA not included

PACKAGING & LOGISTICS INFORMATION

HS Code: 85318040

Carton box

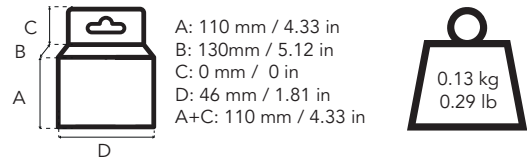

Export carton

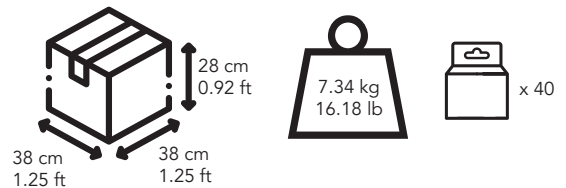

Pallet

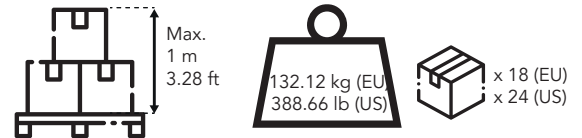

+ 15 kg / 33.06 lb from pallet



- CO² detector
- Temperature
- Humidity



C-LOGIC 7100-AQ

Air quality meter

Code: CLOGIC7100AQCIBINT

EAN code: 8435394782348

UPC code: 810053674895



Más info.

CONTENTS

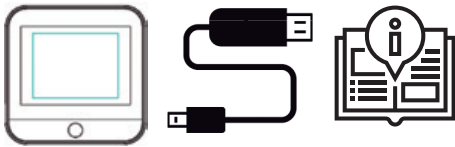

DIMENSIONS

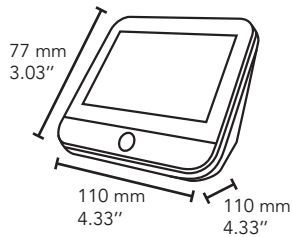

MAIN APPLICATIONS

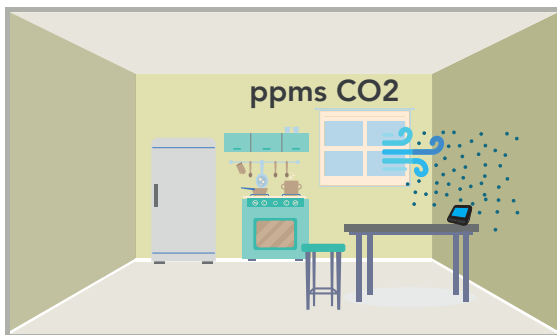

SPECIFICATIONS

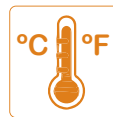

FEATURES

CO² measuring range: 400-5000PPM

CO² sensor: NDIR

Temperature range: -10°C - +50°C

Humidity range: 0% - 85%

Dimensions: 90 x 90 x 50 mm. Weight: 200 g

Power supply: 2200mAh battery

PACKAGING & LOGISTICS INFORMATION

HS code: 85311030

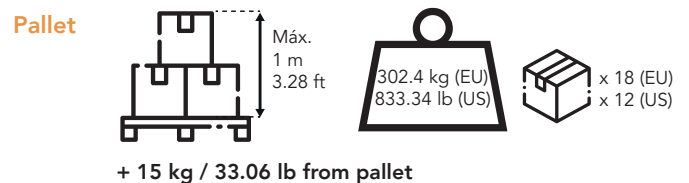
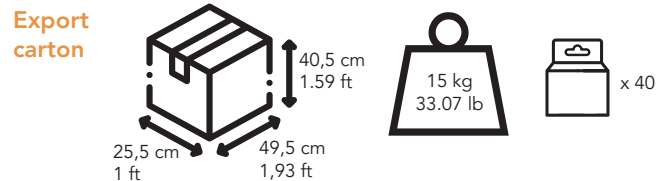
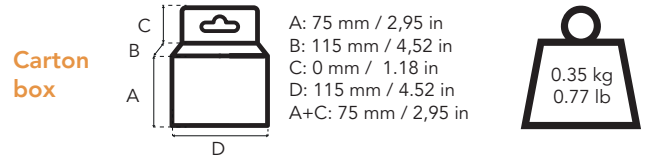



- Smoke detector
- <85dB



C-LOGIC 700-SD

Smoke detector
 Item Code: CLOGIC700SDCBINT
 Prev. Code: 301000033
 EAN Code: 8435394748146
 UPC Code: 810053671320



More info

CONTENTS



MAIN APPLICATIONS

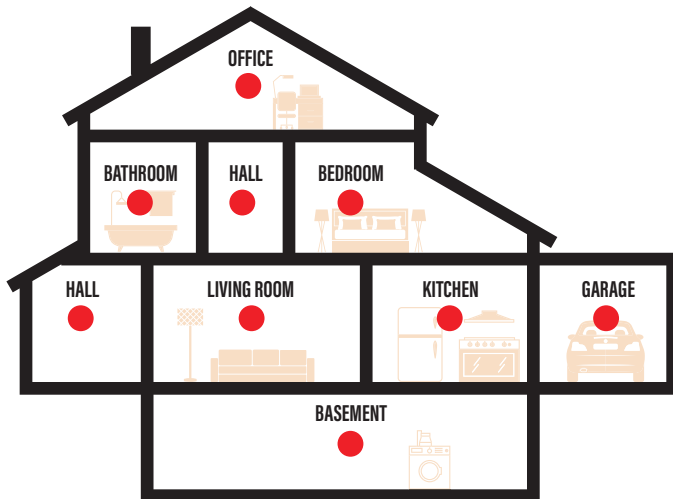

CONNECTION GUIDE

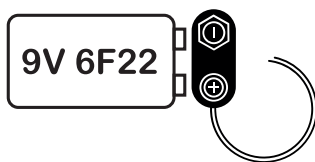

DIMENSIONS



INSTALLATION

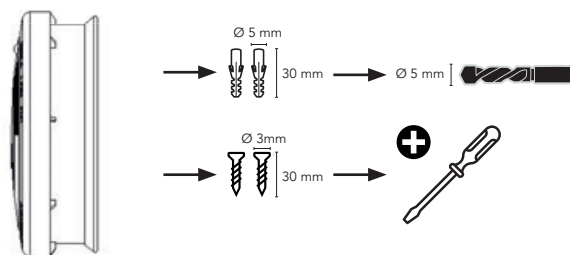

SPECIFICATIONS



FEATURES

Dimensions: 102 x 36 x 69 mm

On-celling installation

Suitable for indoor use

Acoustic indication of low battery

Power supply: 1 x 9V battery included

According to EN 14604:2005 / AC:2008

PACKAGING & LOGISTICS INFORMATION

HS Code: 90278090

Carton box

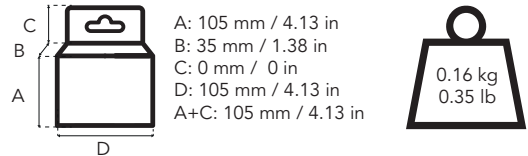

Export carton

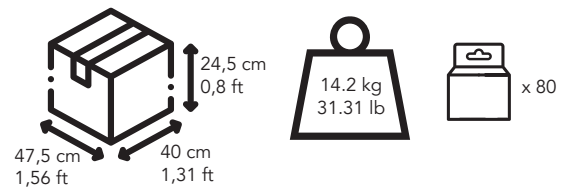

Pallet

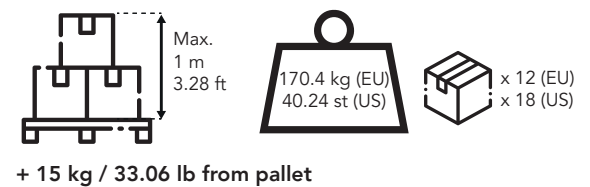



- Mini Smoke detector
- <85dB



C-LOGIC 720-SD

Mini smoke detector
 Item Code: CLOGIC720SDCBINT
 Prev. Code: 301000035
 EAN Code: 8435394748160
 UPC Code: 810053671337

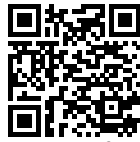

More info

CONTENTS

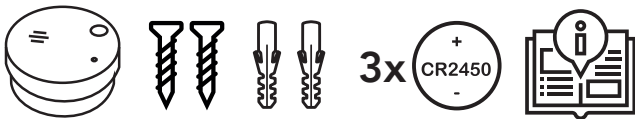

MAIN APPLICATIONS

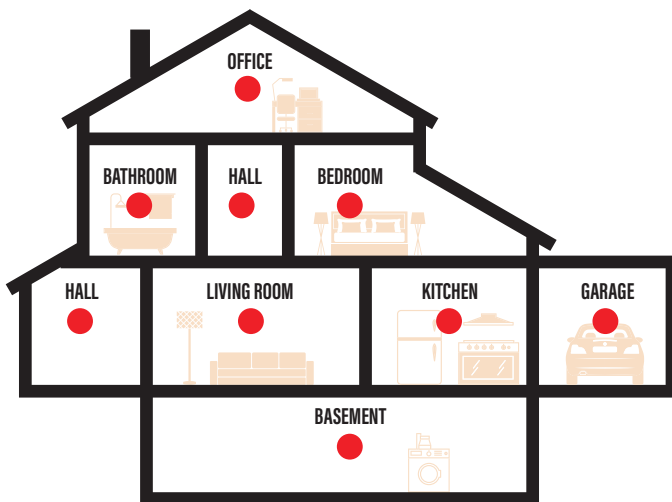

CONNECTION GUIDE

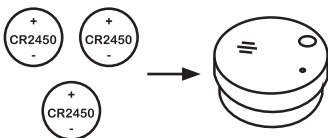

DIMENSIONS



INSTALLATION

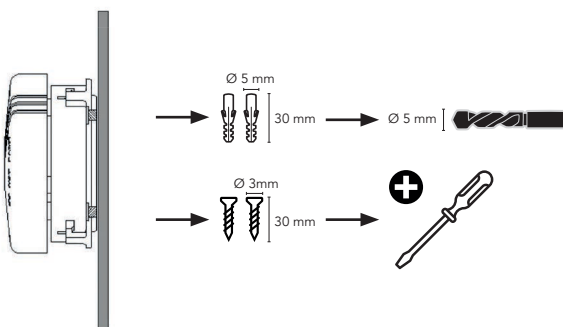

SPECIFICATIONS



FEATURES

- Dimensions: 72 x 37 mm
- On-ceiling installation compact size
- Suitable for indoor use
- Acoustic indication of detection.
- Power supply: 3 x 3V CR2450 batteries included
- According to EN 14604:2005/AC:2008

PACKAGING & LOGISTICS INFORMATION

HS Code: 90278090

Carton box

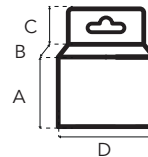

A: 75 mm / 2.95 in
 B: 40 mm / 1.57 in
 C: 0 mm / 0 in
 D: 75 mm / 2.95 in
 A+C: 75 mm / 2.95 in



Export carton

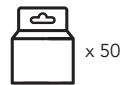
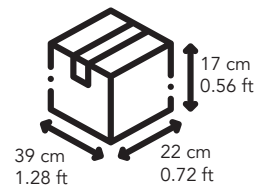

Pallet

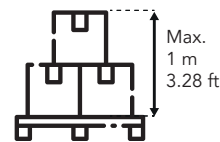

+ 15 kg / 33.06 lb from pallet



- Wireless Smoke Detector
- <85dB



C-LOGIC 710-SD

Wireless smoke detector
 Item Code: CLOGIC710SDCBINT
 Prev. Code: 301000036
 EAN Code: 8435394748177
 UPC Code: 810053671344

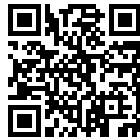

More info

CONTENTS

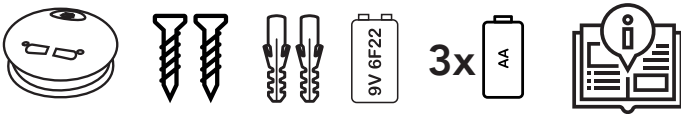

MAIN APPLICATIONS

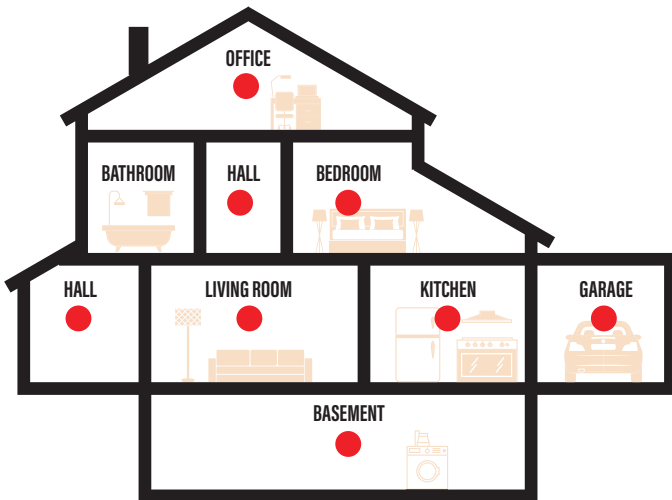

CONNECTION GUIDE

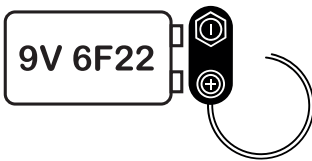

DIMENSIONS



INSTALLATION

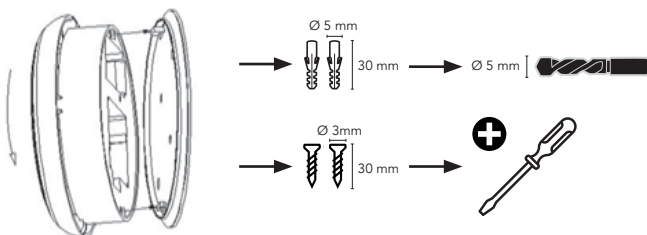

SPECIFICATIONS



FEATURES

- Dimensions: 128 x 49 mm
- On-celling installation
- Suitable for indoor use
- Acoustic indication of detection
- Power supply: 1 x 9V battery + 3 x 1.5V batteries included
- Indication light of operation
- According to EN 14604:2005 / AC:2008

PACKAGING & LOGISTICS INFORMATION

HS Code: 90278090

Carton box

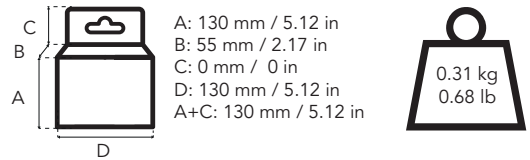

Export carton

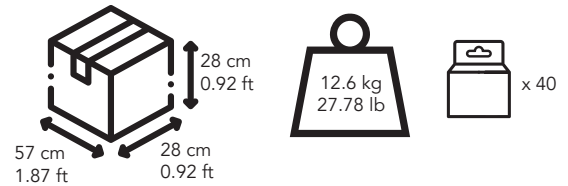

Pallet

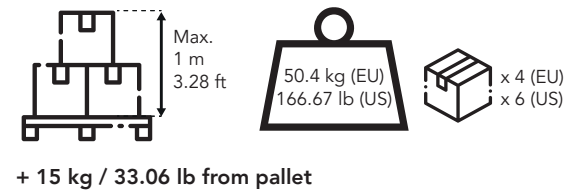



- Gas detector
- Liquid gas and natural gas leakage (LPG) detection
- <85dB



C-LOGIC 770-SD

Gas detector
 Item Code: CLOGIC770SD230VCBINT
 Prev. Code: 301000037
 EAN Code: 8435394748184

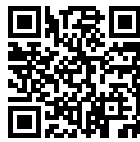

More info

CONTENTS

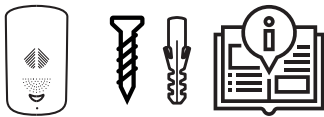

MAIN APPLICATIONS

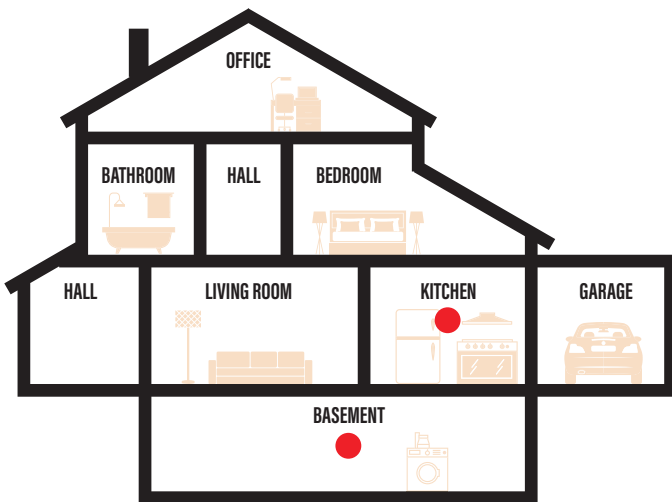

CONNECTION GUIDE

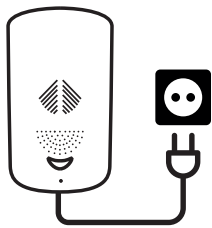

DIMENSIONS

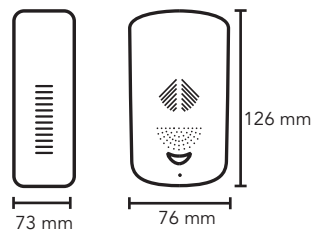

INSTALLATION

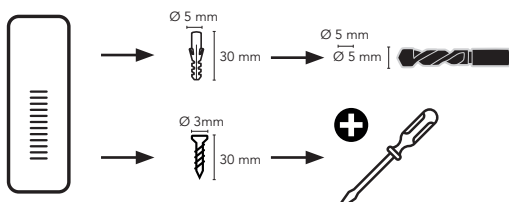

SPECIFICATIONS



FEATURES

Dimensions: 126 x 73 x 76 mm

On-wall installation

Suitable for indoor use

Liquid gas and natural gas leakage (LPG) detection

Acoustic indication of detection

Alarm level: < 25%LEL

Acoustic indication of detection

Power supply: 230VAC 50-60 Hz

Plug type: Schucko

PACKAGING & LOGISTICS INFORMATION

HS Code: 90278090

Carton box

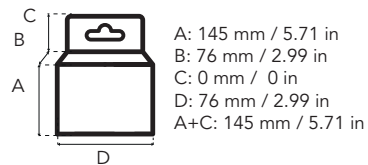

Export carton

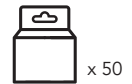
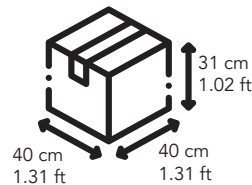

Pallet

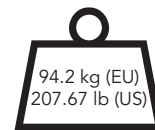
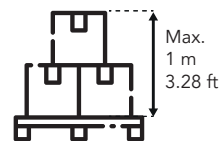

+ 15 kg / 33.06 lb from pallet



- Suitable for the detection of water filtrations
- <85dB
- Response time: <7 seconds



C-LOGIC 730-SD

Flood detector
 Item Code: CLOGIC730SDCBINT
 Prev. Code: 301000040
 EAN Code: 8435394748214
 UPC Code: 810053671375



More info

CONTENTS



MAIN APPLICATIONS

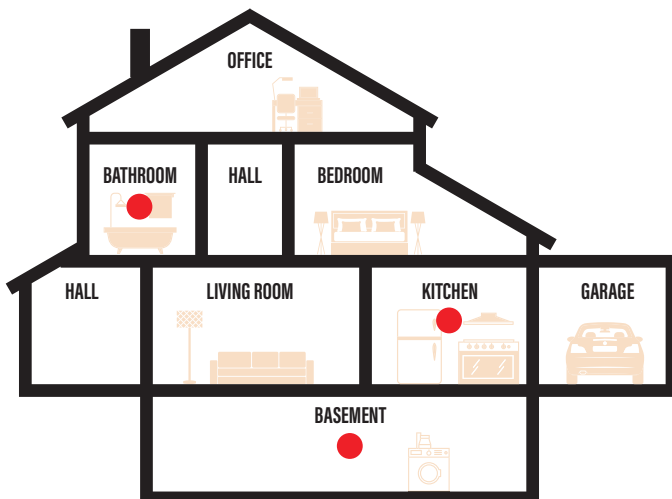

CONNECTION GUIDE

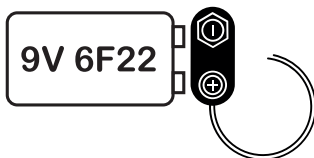

DIMENSIONS

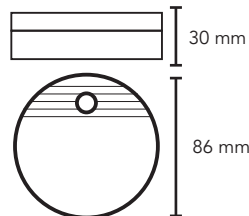

INSTALLATION

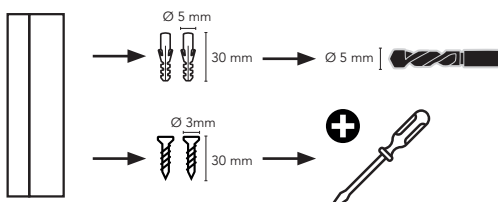

SPECIFICATIONS



FEATURES

Suitable for the detection of water filtrations

Installation on surface

Response time: <7 seconds

Operating temperature: +1°C to 60°C

Power supply: 1 x 9V battery included

Dimensions: 86 x 82 x 30 mm. Weight: 100g

PACKAGING & LOGISTICS INFORMATION

HS Code: 90278090

Carton box

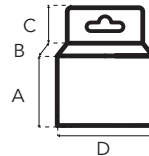

A: 85 mm / 3.35 in
 B: 35 mm / 1.38 in
 C: 0 mm / 0 in
 D: 85 mm / 3.35 in
 A+C: 85 mm / 3.35 in



Export carton

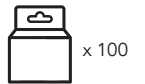
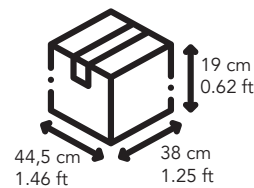

Pallet

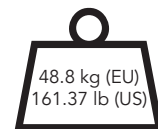
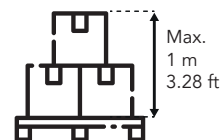

+ 15 kg / 33.06 lb from pallet



- CO detector
- <85dB



C-LOGIC 750-SD

CO detector
 Item Code: CLOGIC750SDCBINT
 Prev. Code: 301000038
 EAN Code: 8435394748191
 UPC Code: 810053671351



More info

CONTENTS



MAIN APPLICATIONS

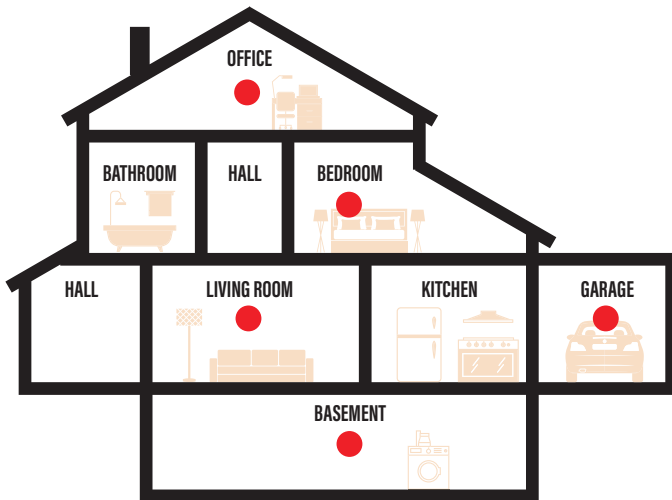

CONNECTION GUIDE

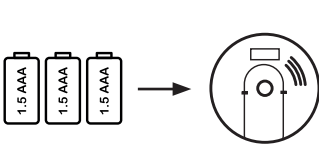

DIMENSIONS

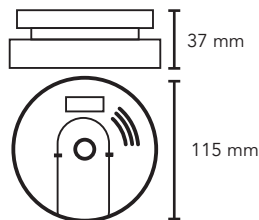

INSTALLATION

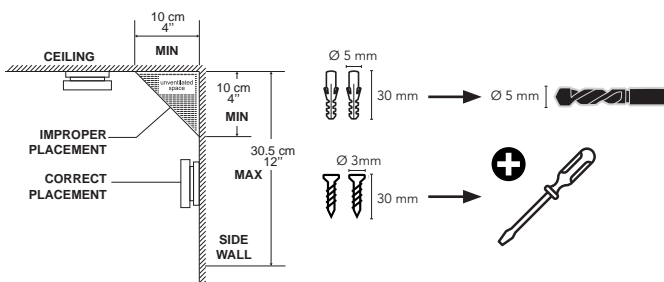

SPECIFICATIONS



FEATURES

- On-ceiling installation
- Suitable for indoor use
- LCD screen with visual indication of CO concentration
- Acoustic and light indication of low battery
- Dimensions: 115 x 37 mm. Weight: 120 g
- Power supply: 3 x 1.5V batteries included

PACKAGING & LOGISTICS INFORMATION

HS Code: 90278090

Carton box

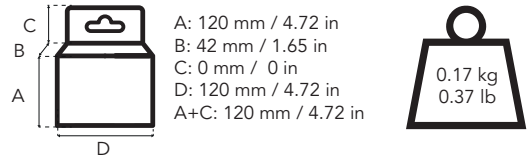

Export carton

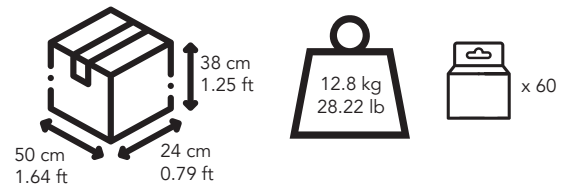

Pallet

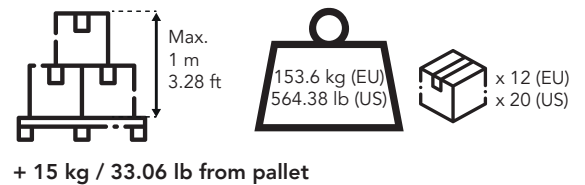



- CO + Smoke detector
- <85dB



C-LOGIC 740-SD

CO+Smoke detector
 Item Code: CLOGIC740SDCBINT
 Prev. Code: 301000084
 EAN Code: 8435394776842
 UPC Code: 810053671481



More info

CONTENTS

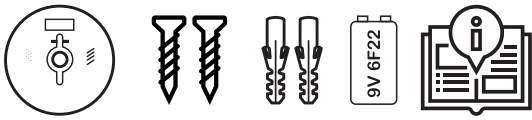

MAIN APPLICATIONS

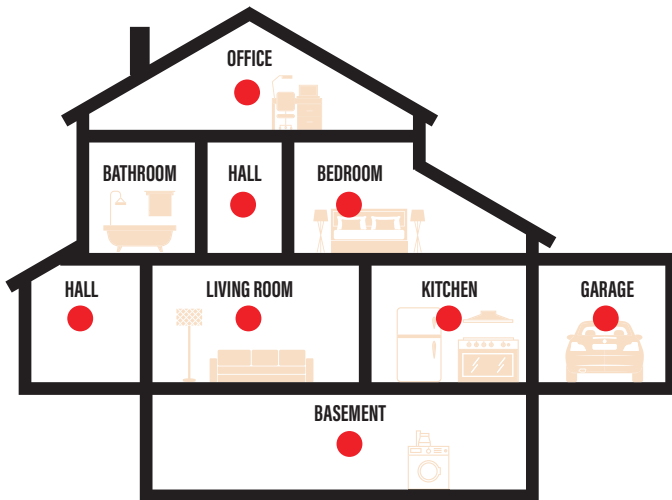

CONNECTION GUIDE

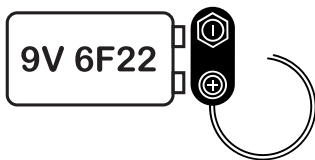

DIMENSIONS

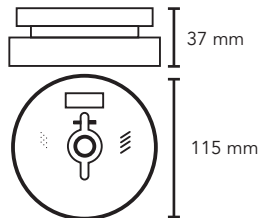

INSTALLATION

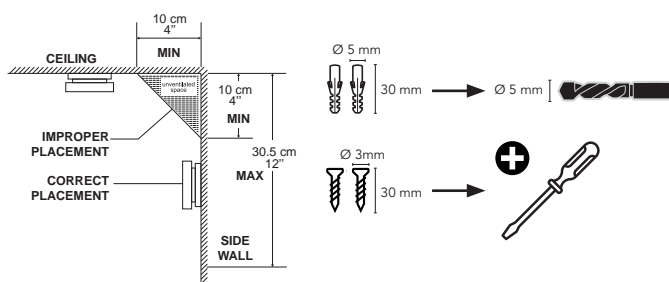

SPECIFICATIONS



FEATURES

- On-celling installation
- Suitable for indoor use
- LCD screen with visual indication of CO concentration and of smoke detection
- Acoustic and light indication of low battery
- Indication light of operation via LED
- Dimensions: 115 x 37 mm. Weight: 120 g
- Power supply: 1 x 9V batteries included

PACKAGING & LOGISTICS INFORMATION

HS Code: 84306243

Carton box

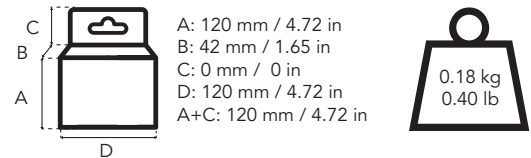

Export carton

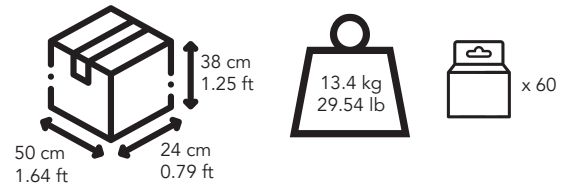

Pallet

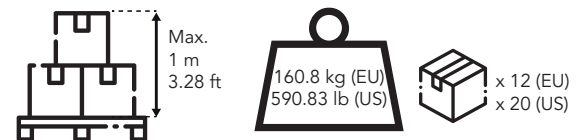

+ 15 kg / 33.06 lb from pallet



- Suitable for the detection of early signs of fire
- <85dB
- Detection temperature 55±5 °C



C-LOGIC 760-SD

Fire detector
 Item Code: CLOGIC760SDCBINT
 Prev. Code: 301000039
 EAN Code: 8435394748207
 UPC Code: 810053671368



More info

CONTENTS

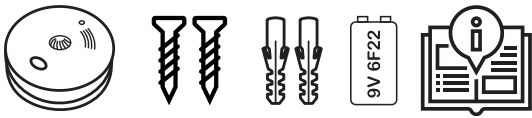

MAIN APPLICATIONS

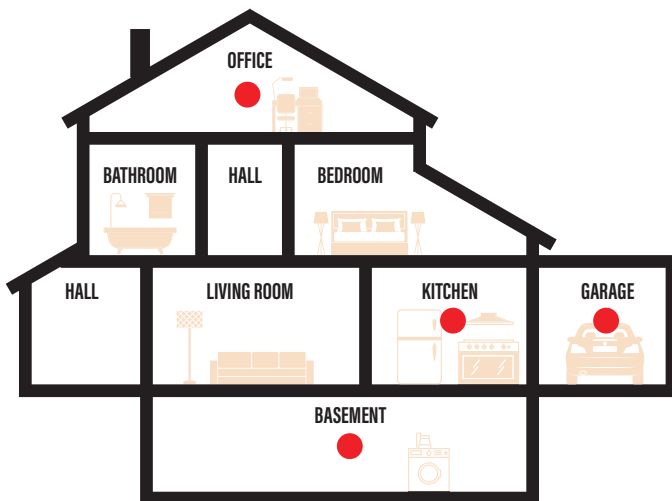

CONNECTION GUIDE

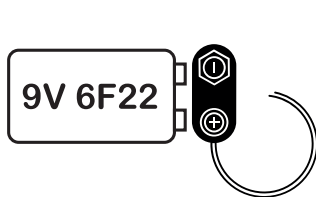

DIMENSIONS

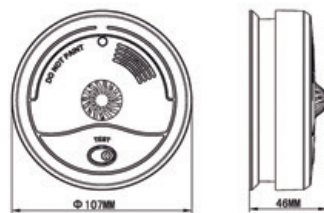

INSTALLATION

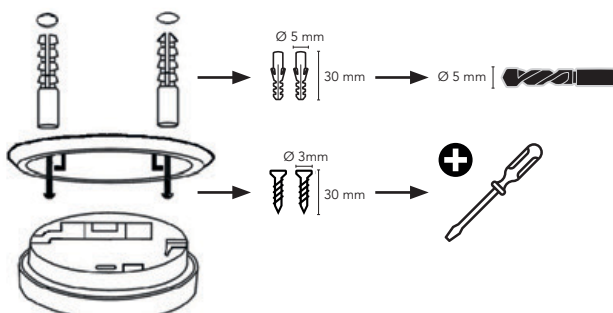

SPECIFICATIONS



FEATURES

- On-wall or on-ceiling installation
- Suitable for indoor use
- Detection temperature 55±5 °C
- Acoustic and light indication of low battery
- Dimensions: 107 x 107 x 37.5 mm. Weight: 220 g
- Power supply: 1 x 9V battery included

PACKAGING & LOGISTICS INFORMATION

HS Code: 90278090

Carton box

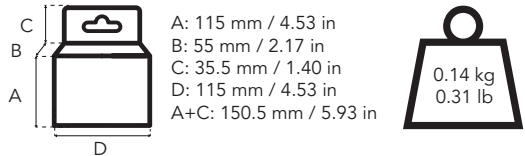

Export carton

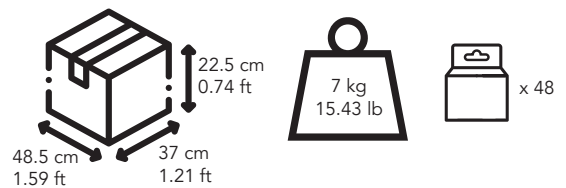

Pallet

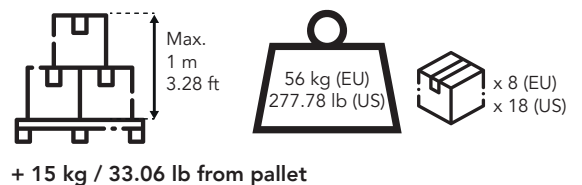



- Digital thermostat for heating or cooling units



C-LOGIC 400-TC

Digital thermostat
 Item Code: CLOGIC400TCCBINT
 Prev. Code: 301000075
 EAN Code: 8435394776750
 UPC Code: 810053671429



More info

CONTENTS

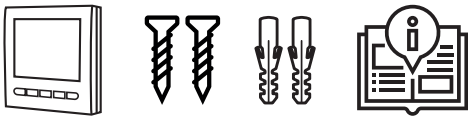

MAIN APPLICATIONS

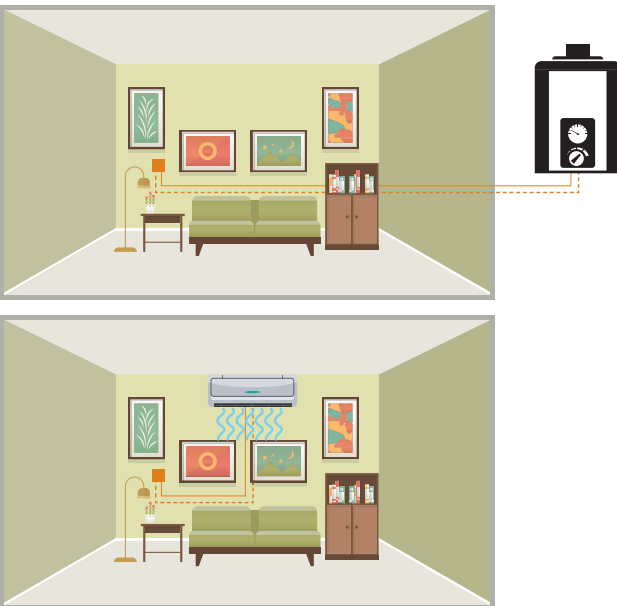

CONNECTION GUIDE

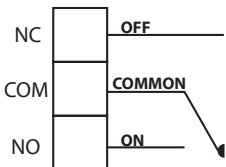

NC: Normally close contact
 COM: Common terminal
 NO: Normally open contact

DIMENSIONS

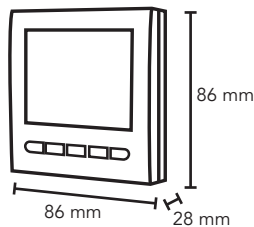

INSTALLATION

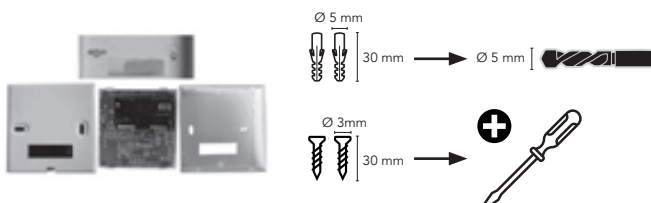

SPECIFICATIONS



FEATURES

- Wall mounted
- LCD screen with backlight display for viewing of the room temperature and set-point temperature
- Free-potential change-over contact with a maximum capacity of 3A
- Programming in 6 daily intervals for workind days and 2 daily intervals for weekend
- Accuracy of measured temperature: 0.5°C
- Range of set temperature from 5°C to 35°C
- Frost protection mode
- Room temperature calibration function
- Powered by 2 AA x 1.5V batteries (not included)
- Dimensions: 86x86x28 mm

PACKAGING & LOGISTICS INFORMATION

HS Code: 90321020

Carton box

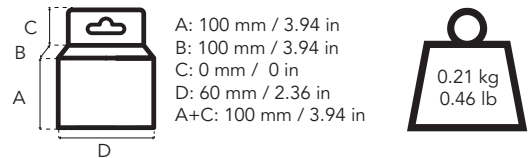

Export carton

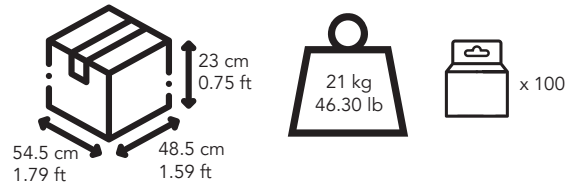

Pallet

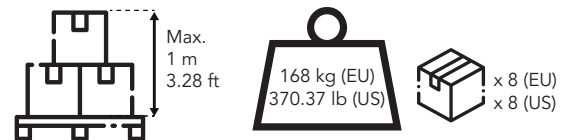

+ 15 kg / 33.06 lb from pallet



- Digital programmable thermostat for heating or cooling units.



More info

C-LOGIC 410-TC

Digital programmable thermostat

Item Code: CLOGIC410TCCBINT

Prev. Code: 301000076

EAN Code: 8435394776767

UPC Code: 810053671436

CONTENTS

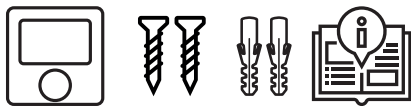

MAIN APPLICATIONS

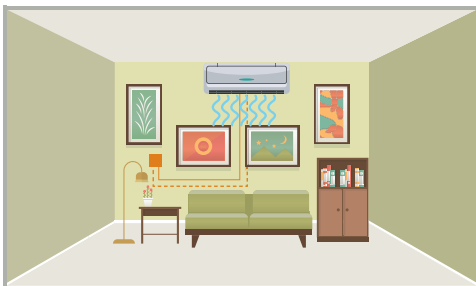
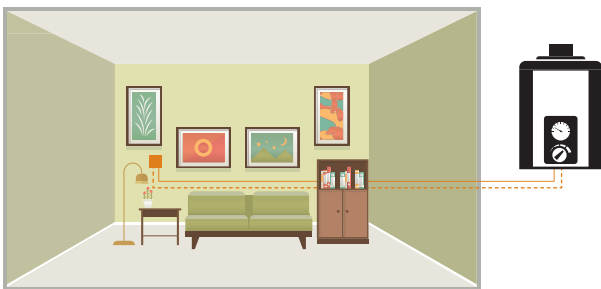

INSTALLATION

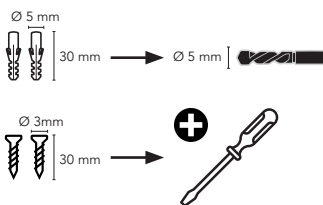

DIMENSIONS

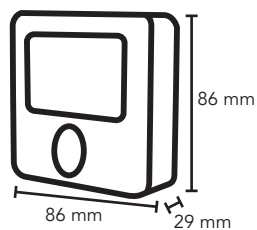

CONNECTION GUIDE

Connection for heating unit

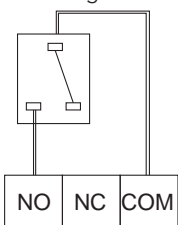

Connection for cooling unit

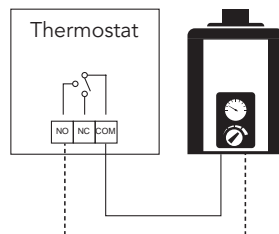
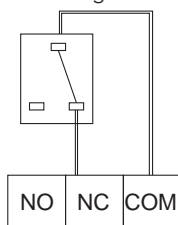

SPECIFICATIONS



FEATURES

Wall mounted

LCD screen with backlight display for viewing the room temperature and the set-point temperature

Free-potential change-over contact with a maximum capacity of 5A/250V

Manual, automatic or holiday mode

Hour-by-hour programming. Two pre-set programs included

Manual setting of comfortable and energy-saving temperatures

Range of measured temperature: 0°C-40°C

Accuracy of measured temperature: 0.5°C

Range of set temperature from 5°C to 35°C

Frost protection mode

Room temperature calibration function

Powered by 2 x 1.5V batteries (not included)

Dimensions: 86x86x29 mm

PACKAGING & LOGISTICS INFORMATION

HS Code: 90321020

Carton box

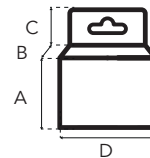

A: 100 mm / 3.94 in
 B: 100 mm / 3.94 in
 C: 0 mm / 0 in
 D: 60 mm / 2.36 in
 A+C: 100 mm / 3.94 in



Export carton

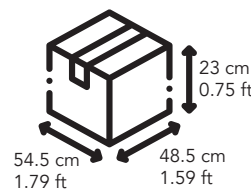

Pallet

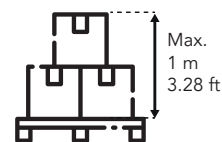

+ 15 kg / 33.06 lb from pallet



- RF Digital programmable thermostat for heating or cooling units.
- Transmitter and a receiver communicated via radio frequency.



C-LOGIC 420-TC

Digital RF programmable thermostat
 Item Code: CLOGIC420TC230VCBINT
 Prev. Code: 301000088
 EAN Code: 8435394776965



More info

CONTENTS



MAIN APPLICATIONS

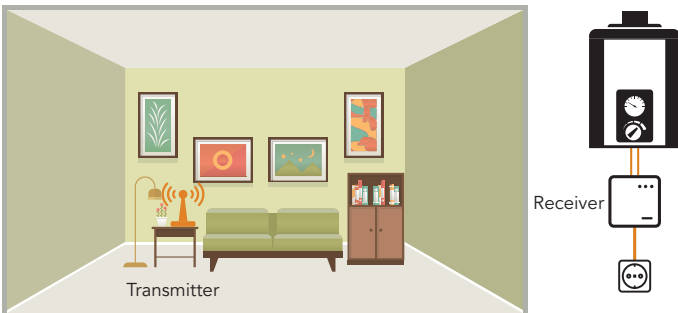

CONNECTION GUIDE

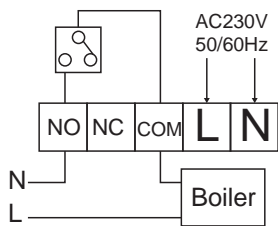

DIMENSIONS

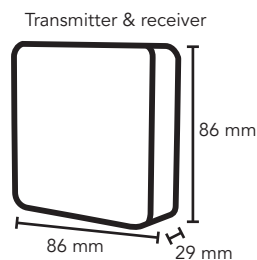

INSTALLATION

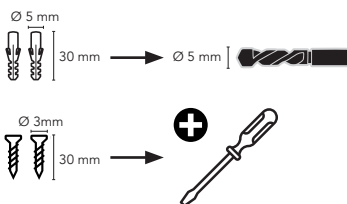

SPECIFICATIONS

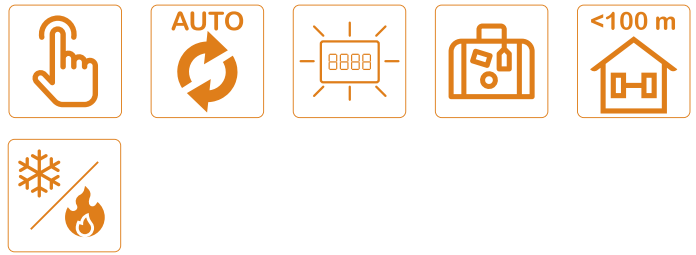

FEATURES

- Wall mounted
- The thermostat consists of a transmitter and a receiver communicated via radio frequency
- Communication distance up to 100 m (more than 30 m inside the buildings)
- LCD screen with backlight display for viewing the room temperature and set-point temperature
- Free-potential change-over contact with a maximum capacity of 5A/230V
- Manual, automatic or holiday mode
- Programming in 6 daily intervals. Two pre-set programs included
- Range of measured temperature: 0°C-40°C
- Accuracy of measured temperature: 0.5°C
- Range of set temperature from 5°C to 35°C
- Room temperature calibration function
- Power supply:
 - Transmitter: 2 AA x 1.5V batteries (not included)
 - Receiver: Connected to the mains (230V 50/60Hz)

PACKAGING & LOGISTICS INFORMATION

HS Code: 90321020

Carton box

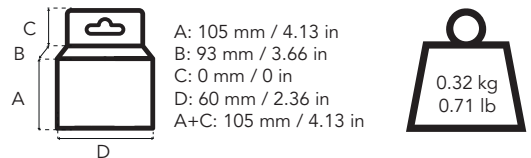

Export carton

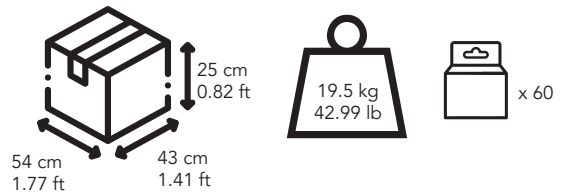

Pallet

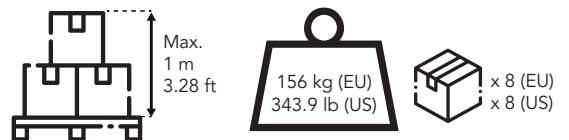

+ 15 kg / 33.06 lb from pallet



- Wifi digital programmable thermostat for heating units.
- Remote control via Wifi by mobile App. Compatible with Alexa
- TUYA platform connectivity, allows the control of different devices with one App



C-LOGIC 900-TC

Digital Wifi programmable thermostat
 Item Code: CLOGIC900TCDUALCBINT
 Prev. Code: 301000089
 EAN Code: 8435394776972



More info

CONTENTS



MAIN APPLICATIONS

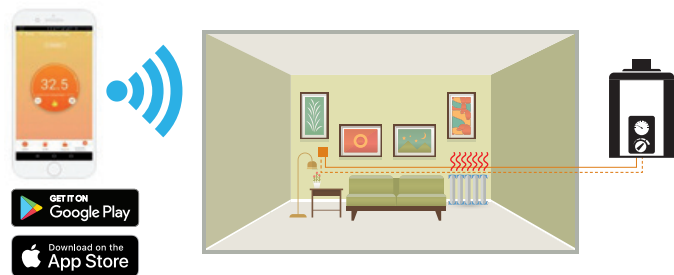

CONNECTION GUIDE

AC90-240V 50/60Hz
 Imax: 3A

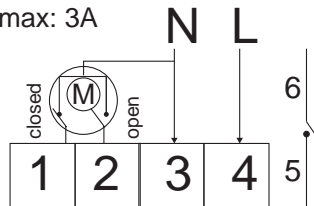

DIMENSIONS

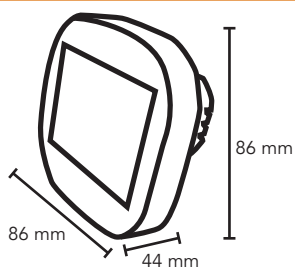

INSTALLATION

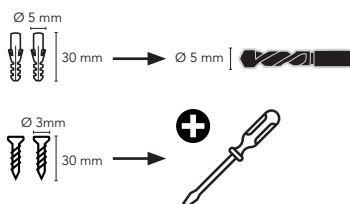

SPECIFICATIONS

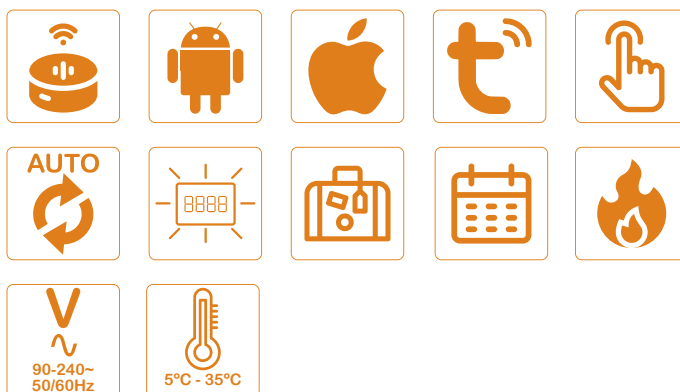

FEATURES

- Installation in flush-mount box
- Remote control via Wifi by mobile App. Compatible with Alexa
- TUYA platform connectivity, allows the control of different devices with one App
- LCD screen with backlight display for viewing the room temperature and set-point temperature
- Free-potential normally-open contact with a maximum capacity of 3A/230V
- Manual, automatic or holiday mode
- Programming in 6 daily intervals
- Range of measured temperature: 0°C-70°C
- Accuracy of measured temperature: 0.5°C
- Range of set temperature from 5°C to 35°C
- Room temperature calibration function
- Power supply: Connected to the mains (90- 240V 50/60Hz)
- Dimensions: 86x86x44 mm

PACKAGING & LOGISTICS INFORMATION

HS Code: 90321020

Carton box

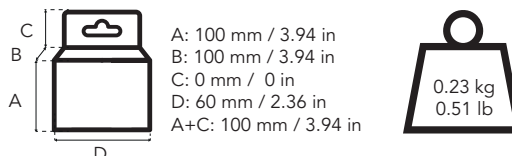

Export carton

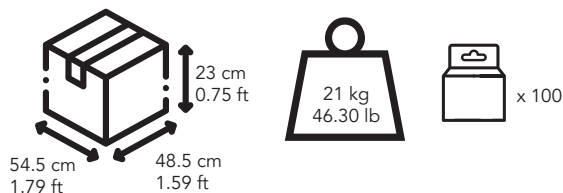

Pallet

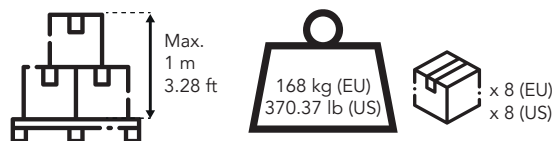

+ 15 kg / 33.06 lb from pallet



- Up to 48 commands per day on / off
- Min operation: 30 minutes



C-LOGIC 300-PT

Plug-In Mechanical Time-Switch
 Item Code: CLOGIC300PT125VCBINT
 Prev. Code: 301000080
 EAN Code: 8435394776804
 UPC Code: 810053671443

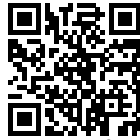

More info

CONTENTS

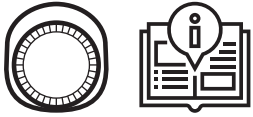

MAIN APPLICATIONS



CONNECTION GUIDE

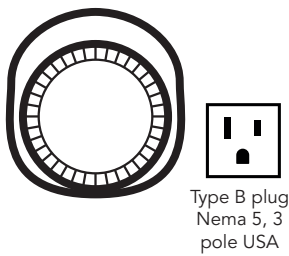

DIMENSIONS

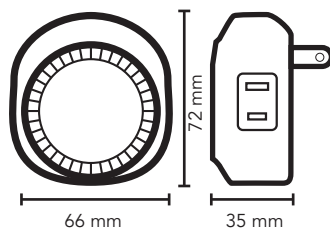

INSTALLATION

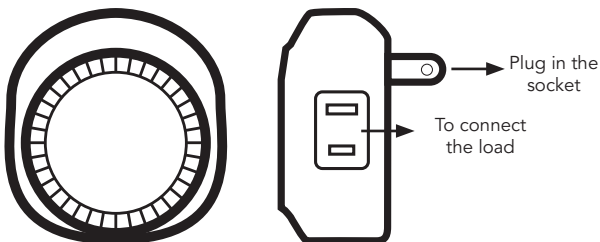

SPECIFICATIONS



FEATURES

- Up to 48 programs per day
- Power supply: 125V~, 50-60Hz
- Min operation: 30 minutes
- Max Load: 15A (Resistive)
- Operation modes: ON/AUTO

PACKAGING & LOGISTICS INFORMATION

HS Code:

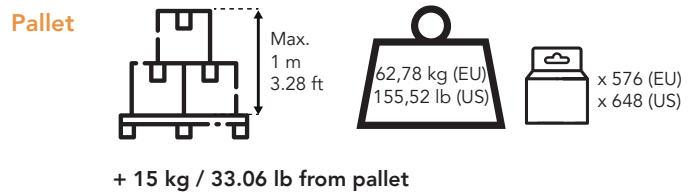
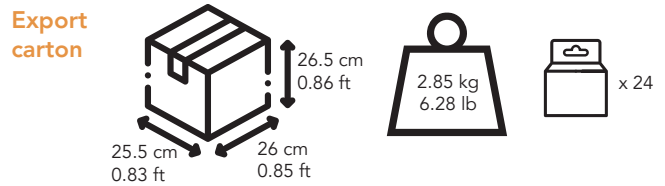
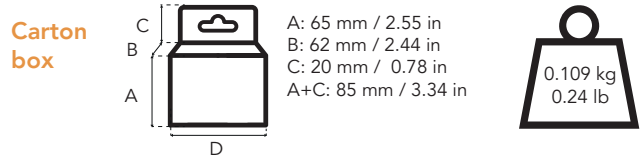



- Set specific on / off times for your appliances such as coffeemaker, lamps, etc.
- Ideal for energy saving
- Large LCD screen, shows the status of the selected program and the real time



More info

C-LOGIC 310-PT

Plug-In Digital Time-Switch
 Item Code: CLOGIC310PT125VCBINT
 Prev. Code: 301000081
 EAN Code: 8435394776811
 UPC Code: 810053671450

CONTENTS



MAIN APPLICATIONS

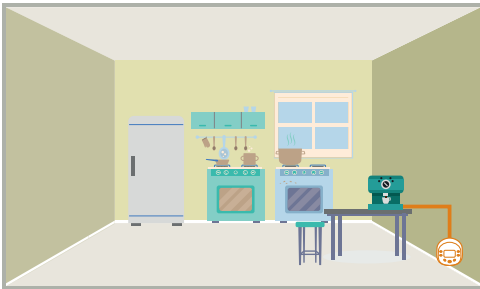

CONNECTION GUIDE

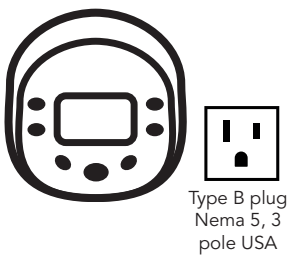

Type B plug
 Nema 5, 3
 pole USA

DIMENSIONS

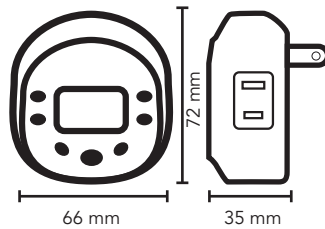

INSTALLATION

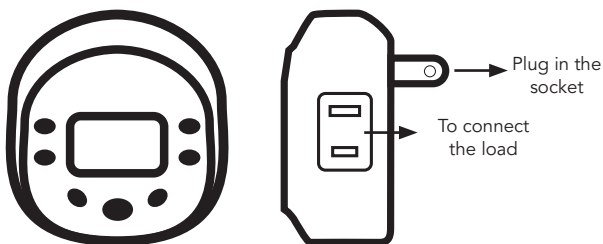

SPECIFICATIONS



FEATURES

Maximum of 140 weekly on/off programs

Power supply: 125V~, 50-60Hz

Minimum 1 min interval

Max Load: 15A (Resistive)

Operation modes: ON/OFF/AUTO

PACKAGING & LOGISTICS INFORMATION

HS Code: 9106900000

Carton box

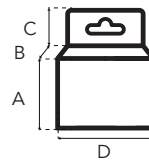

A: 65 mm / 2.55 in
 B: 79 mm / 3.11 in
 C: 20 mm / 0.78 in
 A+C: 85 mm / 3.34 in



Export carton

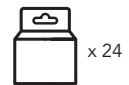
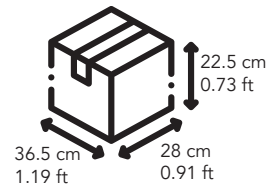

Pallet

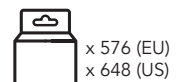
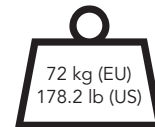
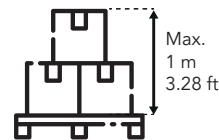

+ 15 kg / 33.06 lb from pallet



- Provides basic daily program setting
- Added protection with grounded outlet
- Outdoor timer, perfect for controlling outdoor lighting, decorations, fountains...etc



C-LOGIC 320-PT

Outdoor Plug-In Mechanical Timer
 Item Code: CLOGIC320PT125VCBINT
 Prev. Code: 301000082
 EAN Code: 8435394776828
 UPC Code: 810053671467



More info

CONTENTS



MAIN APPLICATIONS

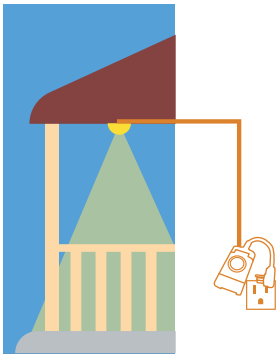

CONNECTION GUIDE

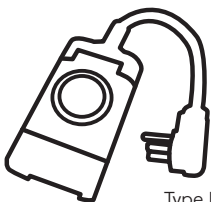

Type B plug
 Nema 5, 3
 pole USA

DIMENSIONS

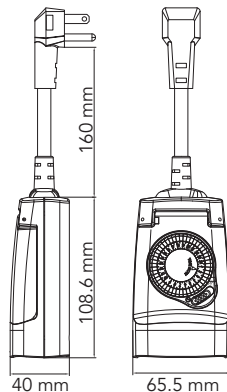

INSTALLATION

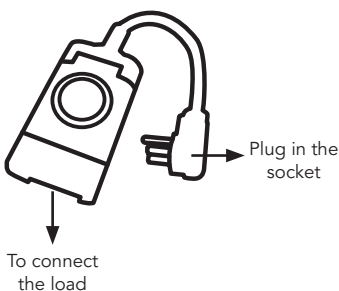

SPECIFICATIONS

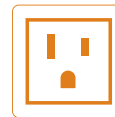

FEATURES

- Programmable in 30-minute intervals
- Maximum 48 individual ON/OFF setting per day
- Cable: 14AWG x 3C SJTW UL approved PVC cable
- Power supply: 125V~, 60Hz
- Max Load: 15A (Resistive)
- Protection degree: IP41

PACKAGING & LOGISTICS INFORMATION

HS Code:

Carton box

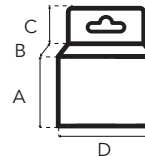

A: 153 mm / 6.02 in
 B: 69 mm / 2.71 in
 C: 40 mm / 1.57 in
 A+C: 193 mm / 7.59 in



Export carton

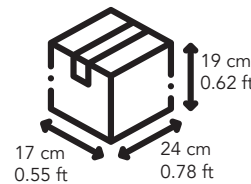

Pallet

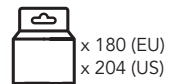
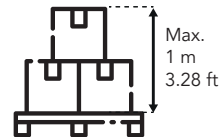

+ 15 kg / 33.06 lb from pallet



- Unique design to hold the smartphone safety while charging
- Single outlet, grounded



C-LOGIC 330-PT

Plug Socket with USB
 Item Code: CLOGIC330PT125VCBINT
 Prev. Code: 301000083
 EAN Code: 8435394776835
 UPC Code: 810053671474



More info

CONTENTS



MAIN APPLICATIONS

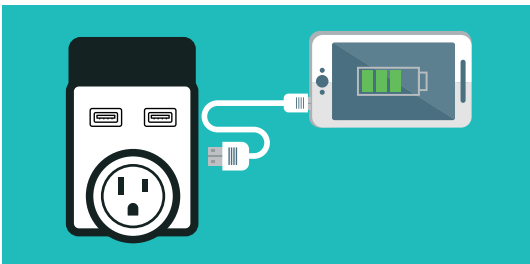

CONNECTION GUIDE

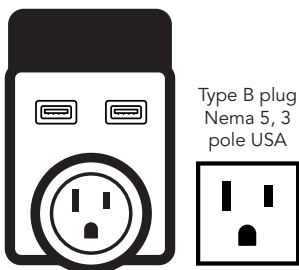

Type B plug
 Nema 5, 3
 pole USA

DIMENSIONS

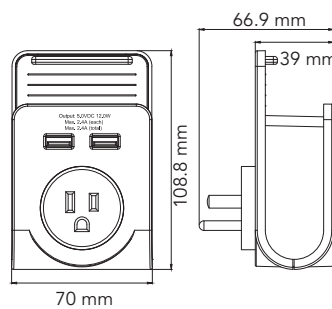

INSTALLATION

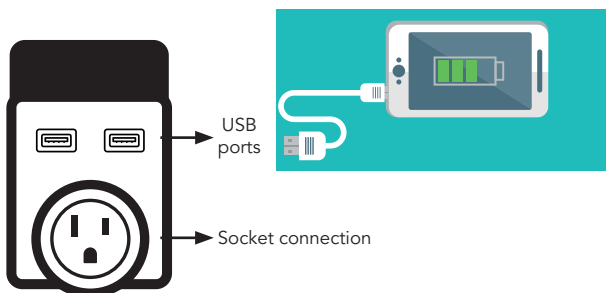

SPECIFICATIONS



FEATURES

USB output voltage: 5VDC, 2,4A

USB output current: Max. 2400mA for 2 USB ports using simultaneously

USB input: 125VAC, 60Hz

Children protector

Max. Load: 125V~ 60Hz, 15A, 1875W (Resistive)

PACKAGING & LOGISTICS INFORMATION

HS Code: 85366990

Carton box

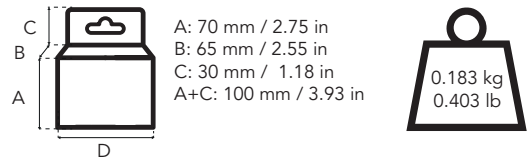

Export carton

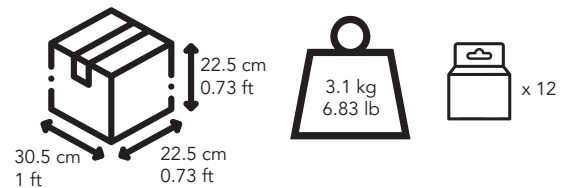

Pallet

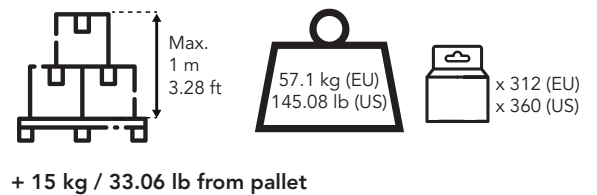

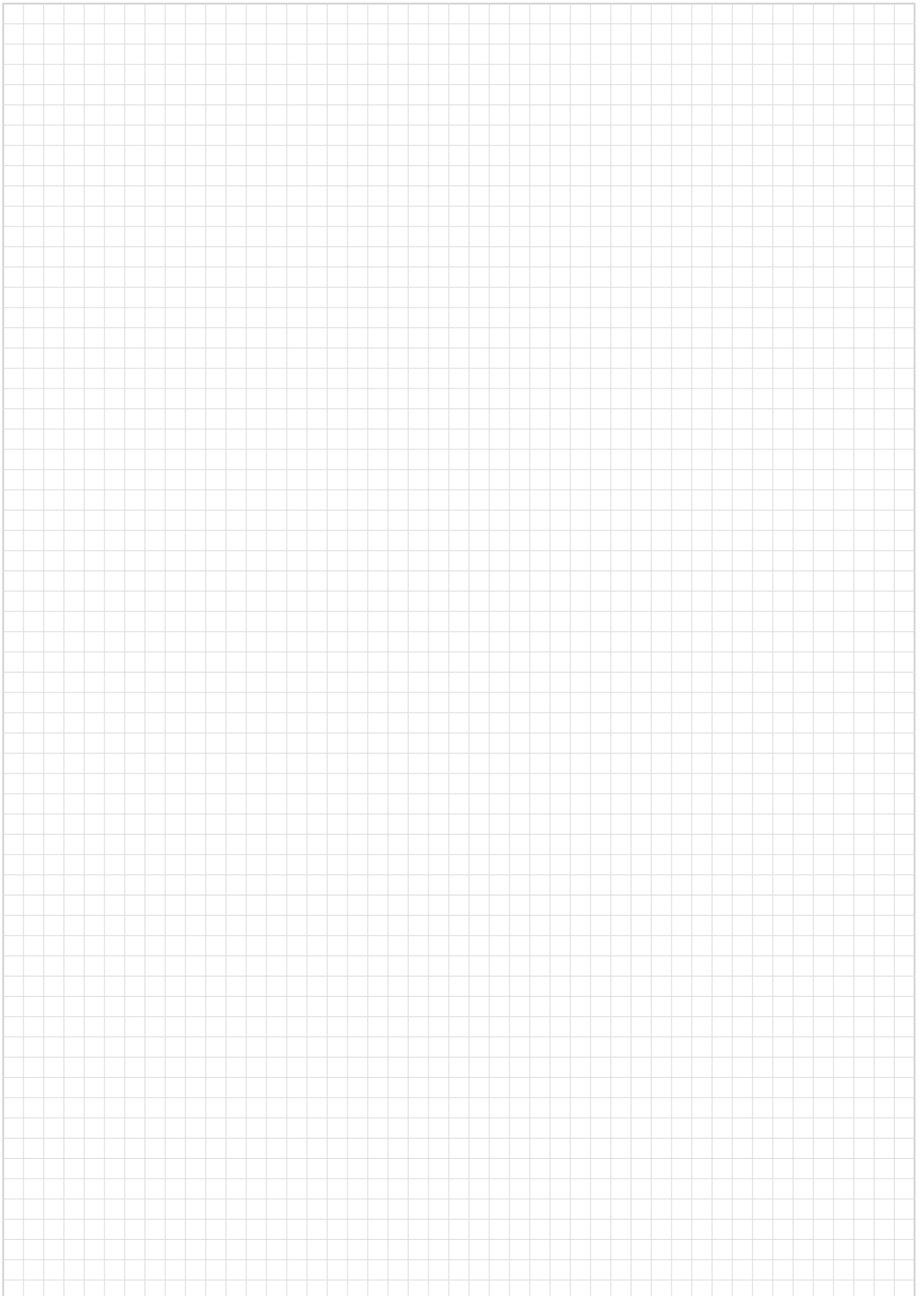



INSTALLATION

- FISH TAPES
- FISH TAPES REEL
- LUBRICANT FOR CABLE GUIDES
- INSULATING GEL

SYMBOL	DESCRIPTION
	Diameter
	Available lengths
	Max. tensile strength
	Optimal tube diameter
	Cable terminals
	Interchangeables terminals
	Head rotation
	Fish tapes reels diameters
	Biodegradable

SYMBOL	DESCRIPTION
	Non corrosive
	Non toxic
	Non flammable
	Surge protection
	Ph neutral
	Dropper
	Protection degree
	Drying time
	Insulation power



- Made on Nylon
- Diameter: 3 mm.
- Fixed spring terminals
- Natural color
- Good Resistance
- Durability.
- High Flexibility
- Different models with different lengths



More info

C-LOGIC 300 series

Nylon cable guides

SPECIFICATIONS

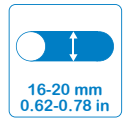
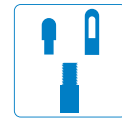
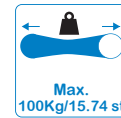
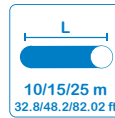
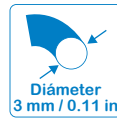

Ref. Name	Length	Diameter	Tensile Strength	Terminals
C-LOGIC 310N-FT	10 m	3 mm	100 kg	Fixed
C-LOGIC 315N-FT	15 m	3 mm	100 kg	Fixed
C-LOGIC 325N-FT	25 m	3 mm	100 kg	Fixed

PACKAGING & LOGISTICS INFORMATION

HS Code: 82055980

Check available packaging options.

ARTICLE	C-LOGIC 310N-FT	C-LOGIC 315N-FT	C-LOGIC 325N-FT
Code	CLOGIC310NFTCBINT	CLOGIC315NFTCBINT	CLOGIC325NFTCBINT
Prev. Code	301000105	301000106	301000107
EAN	8435394777139	8435394777146	8435394777153
UPC	810053671658	810053671665	810053671672

CONTENTS

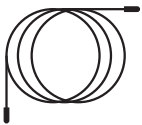

MAIN APPLICATIONS



DOMESTIC

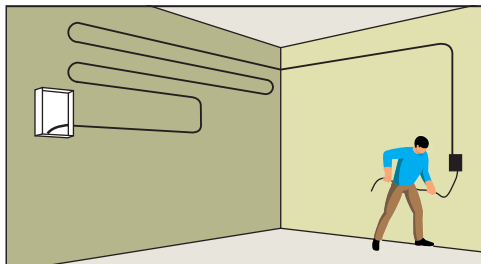

INDUSTRIAL

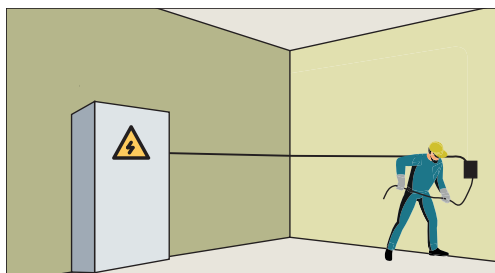



- Shrink wrapping Polipropilen cover with Internal Steel cord.
- Diameter: 4 mm.
- Interchangeables terminals (M5)
- Orange Color
- High resistance and durability
- Different models with different lengths



C-LOGIC 400 series

Polypropylen cable guides



More info

SPECIFICATIONS

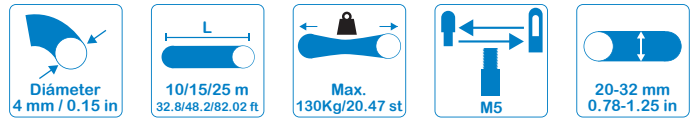

Ref. Name	Length	Diameter	Tensile Strength	Terminals
C-LOGIC 410SC-FT	10 m	4 mm	130 kg	Interchangeables
C-LOGIC 415SC-FT	15 m	4 mm	130 kg	Interchangeables
C-LOGIC 425SC-FT	25 m	4 mm	130 kg	Interchangeables

PACKAGING & LOGISTICS INFORMATION

HS Code: 82055980

Check available packaging options.

ARTICLE	C-LOGIC 410SC-FT	C-LOGIC 415SC-FT	C-LOGIC 425SC-FT
Code	CLOGIC410SCFTCBINT	CLOGIC415SCFTCBINT	CLOGIC425SCFTCBINT
Prev. Code	301000108	301000109	301000110
EAN	8435394777160	8435394777177	8435394777184
UPC	810053671689	810053671696	810053671702

CONTENTS

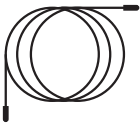

MAIN APPLICATIONS



DOMESTIC

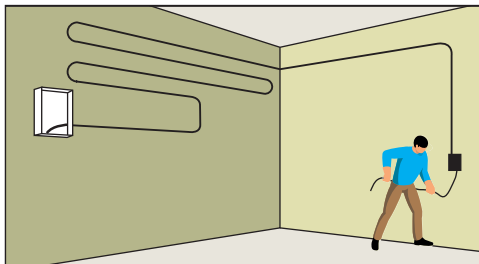

INDUSTRIAL

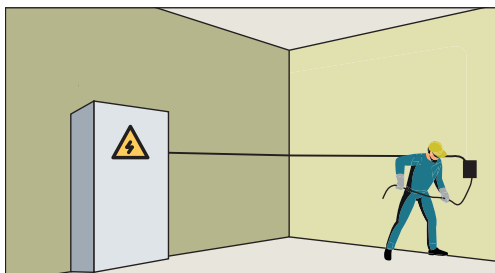



- Braided polyamide
- Diameter: 5-6,3 mm.
- Interchangeable terminals (M5)
- Orange Color
- High resistance and durability
- Different models with different lengths



More info

C-LOGIC 500 series

Polyamide braided cable guides

ARTICLE	C-LOGIC 510BC-FT	C-LOGIC 515BC-FT
Code	CLOGIC510BCFTCBINT	CLOGIC515BCFTCBINT
Prev. Code	301000111	301000112
EAN	8435394777191	8435394777207
UPC	810053671719	810053671726

ARTICLE	C-LOGIC 525BC-FT	C-LOGIC 720BC-FT
Code	CLOGIC525BCFTCBINT	CLOGIC720BCFTCBINT
Prev. Code	301000113	301000114
EAN	8435394777214	8435394777221
UPC	810053671733	810053671740

CONTENTS

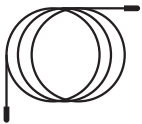

MAIN APPLICATIONS

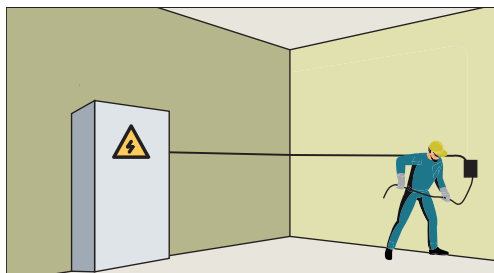
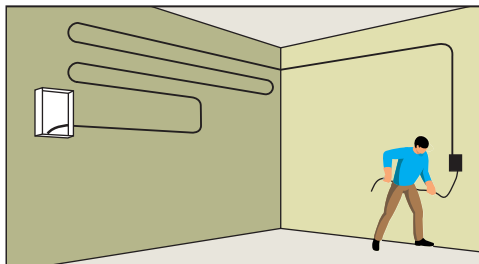

SPECIFICATIONS

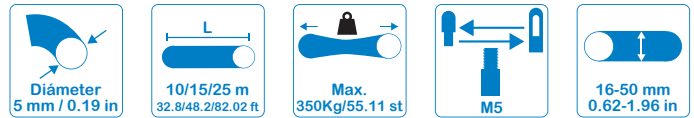

Ref. Name	Length	Diameter	Tensile Strength	Terminals
C-LOGIC 510BC-FT	10 m	5 mm	350 kg	Interchangeables
C-LOGIC 515BC-FT	15 m	5 mm	350 kg	Interchangeables
C-LOGIC 525BC-FT	25 m	5 mm	350 kg	Interchangeables
C-LOGIC 720BC-FT	20 m	6.3 mm	500 kg	Interchangeables

PACKAGING & LOGISTICS INFORMATION

HS Code: 82055980

Check available packaging options.



- Made on steel
- Diameter: 3 mm.
- Interchangeable terminals
- Polypropylene case and handle with impact resistance
- Durability.
- High Flexibility
- Different models with different lengths



C-LOGIC 300SC-FTR series

Steel spiral Fish Tape



More info

ARTICLE	C-LOGIC 376SCS-FTR	C-LOGIC 320SCS-FTR
Code	CLOGIC376SCSFTRCBINT	CLOGIC320SCSFTRCBINT
Prev. Code	301000136	301000137
EAN	8435394777573	8435394777580
UPC	810053671894	810053671900

ARTICLE	C-LOGIC 330SCS-FTR
Code	CLOGIC330SCSFTRCBINT
Prev. Code	301000138
EAN	8435394777597
UPC	810053671917

CONTENTS



MAIN APPLICATIONS

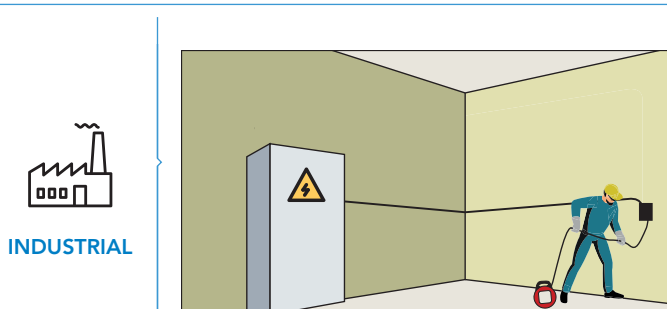
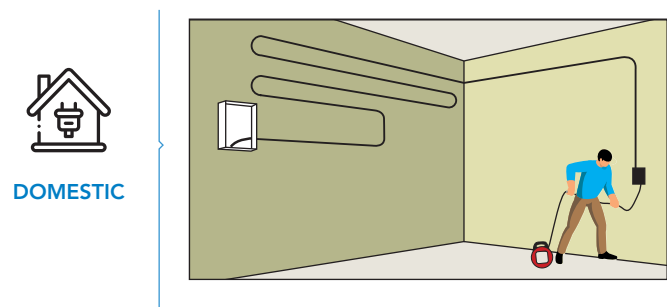

SPECIFICATIONS

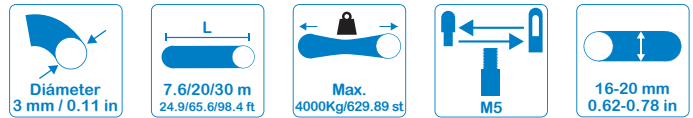

Ref. Name	Length	Diameter	Tensile Strength	Terminals
C-Logic 376SC-FTR	7.6 m	3 mm	4000 kg	Interchangeables
C-Logic 320SC-FTR	20 m	3 mm	4000 kg	Interchangeables
C-Logic 330SC-FTR	30 m	3 mm	4000 kg	Interchangeables

PACKAGING & LOGISTICS INFORMATION

HS Code: 82055980

Check available packaging options.



- Made on poliamide
- Diameter: 4 mm.
- Interchangeable terminals
- Polypropylene case and handle with impact resistance
- Durability
- High Flexibility
- Different models with different lengths



C-LOGIC 400N-FTR series

Spring nylon Fish Tape



More info

ARTICLE	C-LOGIC 420N-FTR	C-LOGIC 430N-FTR
Code	CLOGIC420NFTRCBINT	CLOGIC430NFTRCBINT
Prev. Code	301000139	301000140
EAN	8435394777603	8435394777610
UPC	810053671924	810053671931

CONTENTS



MAIN APPLICATIONS

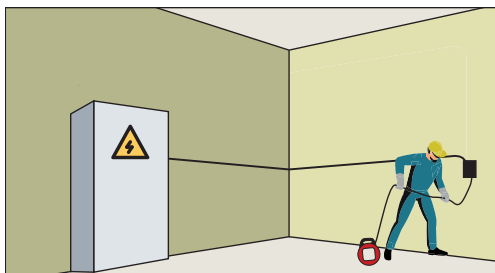
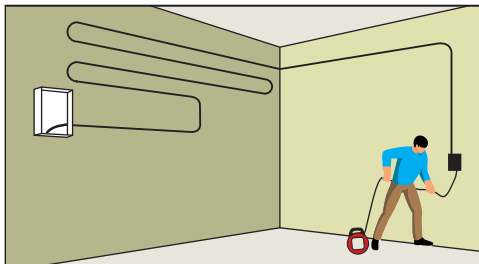

SPECIFICATIONS

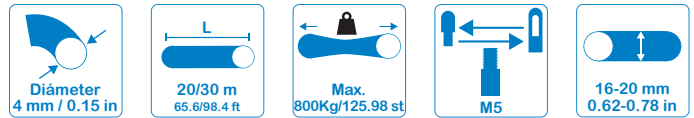

Ref. Name	Length	Diameter	Tensile Strength	Terminals
C-Logic 420N-FTR	20 m	4 mm	800 kg	Interchangeables
C-Logic 430N-FTR	30 m	4 mm	800 kg	Interchangeables

PACKAGING & LOGISTICS INFORMATION

HS Code: 82055980

Check available packaging options.



- Made on steel
- Diameter: 3x1.5 mm.
- Interchangeable terminals
- Polypropylene case and handle with impact resistance
- Durability.
- High Flexibility



C-LOGIC 315SS-FTR series

Spring Steel Fish Tape
 Item Code: CLOGIC315SSTRRCBINT
 Prev. Code: 301000135
 EAN Code: 8435394777566
 UPC Code: 810053671887



More info

CONTENTS



MAIN APPLICATIONS



DOMESTIC

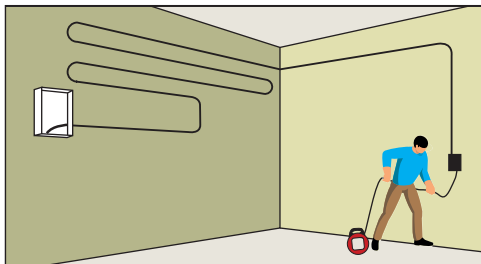

INDUSTRIAL

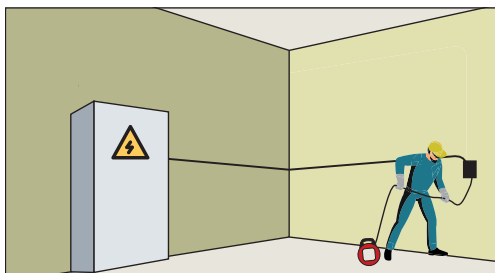

SPECIFICATIONS

Measures 3x1.5 mm / 0.11x0.05 in	15 m 49.21 ft	Max. 130Kg/20.47 st	M5	16-20 mm 0.62-0.78 in
-------------------------------------	------------------	------------------------	----	--------------------------

Ref. Name	Length	Diameter	Tensile Strength	Terminals
C-Logic 315SS-FTR	7.6 m	3 mm	-	Interchangeables

PACKAGING & LOGISTICS INFORMATION

HS Code: 82055980

Check available packaging options.



- Excellent lubricant for pulling of both electrical and communication cable
- No wax, grease or silicone added
- Non-corrosive to steel, copper, or aluminum
- Maximum friction reduction – For long pulls and difficult pulling applications
- Safe for user and environment – Non toxic, non flammable, harmless to skin on contact, biodegradable
- Compatible – To a wide range of cable jackets and conduits
- Easy application – By hand, sponge or directly from the bottle through the dropper nozzle
- Easy clean up – By wiping with water

C-LOGIC 160AC-FT

Cable guides lubricant

Item Code: CLOGIC160ACFTPEINT

Prev. Code: 301000116

EAN Code: 8435394777245

UPC Code: 810053671764



More info

CONTENTS



MAIN APPLICATIONS

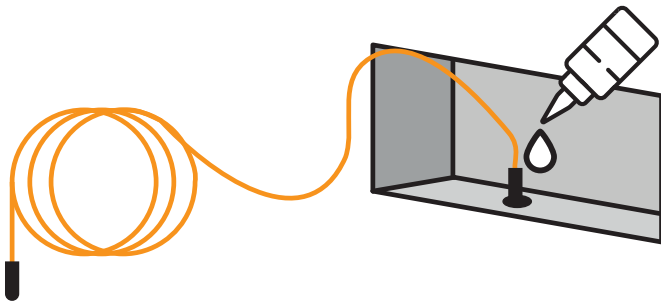

SPECIFICATIONS



FEATURES

Appearance	Gel
Colour	Blue
Odour	None, characterisitc
pH	7
Melting or freezing point.	-10 °C
Initial boiling point	100 °C
Specific gravity	1,000 Kg/l
Solubility	completely in water.
Viscosity	About 35.000 cps

PACKAGING & LOGISTICS INFORMATION

HS Code: 34039900

Check available packaging options.



- Bicomponent gel
- Fast reticulation about 15 minutes at 20°C
- It polymerizes even with low temperatures
- Low viscosity, no-toxic, good transparency
- Re-accessible
- No expiry date



C-LOGIC 180AC-FT

Insulating gel
 Item Code: CLOGIC180ACFTPEINT
 Prev. Code: 301000130
 EAN Code: 8435394877518
 UPC Code: 810053671795



More info

CONTENTS

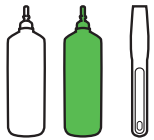

MAIN APPLICATIONS

1



2

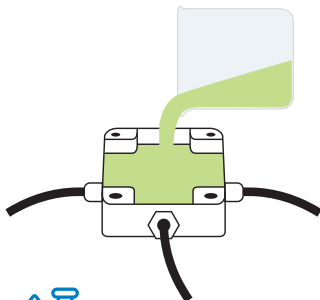

3

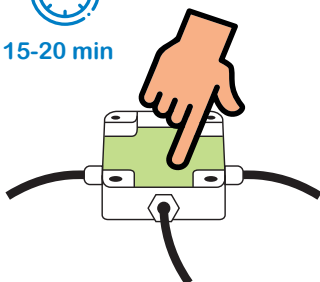

SPECIFICATIONS

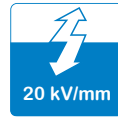

General

Do not store below 4°C

Dielectric strength: 20Kv/mm

Suitable for installations until 1Kv

Protection grade provided: IP68

PACKAGING & LOGISTICS INFORMATION

HS Code: 34039900

Check available packaging options.

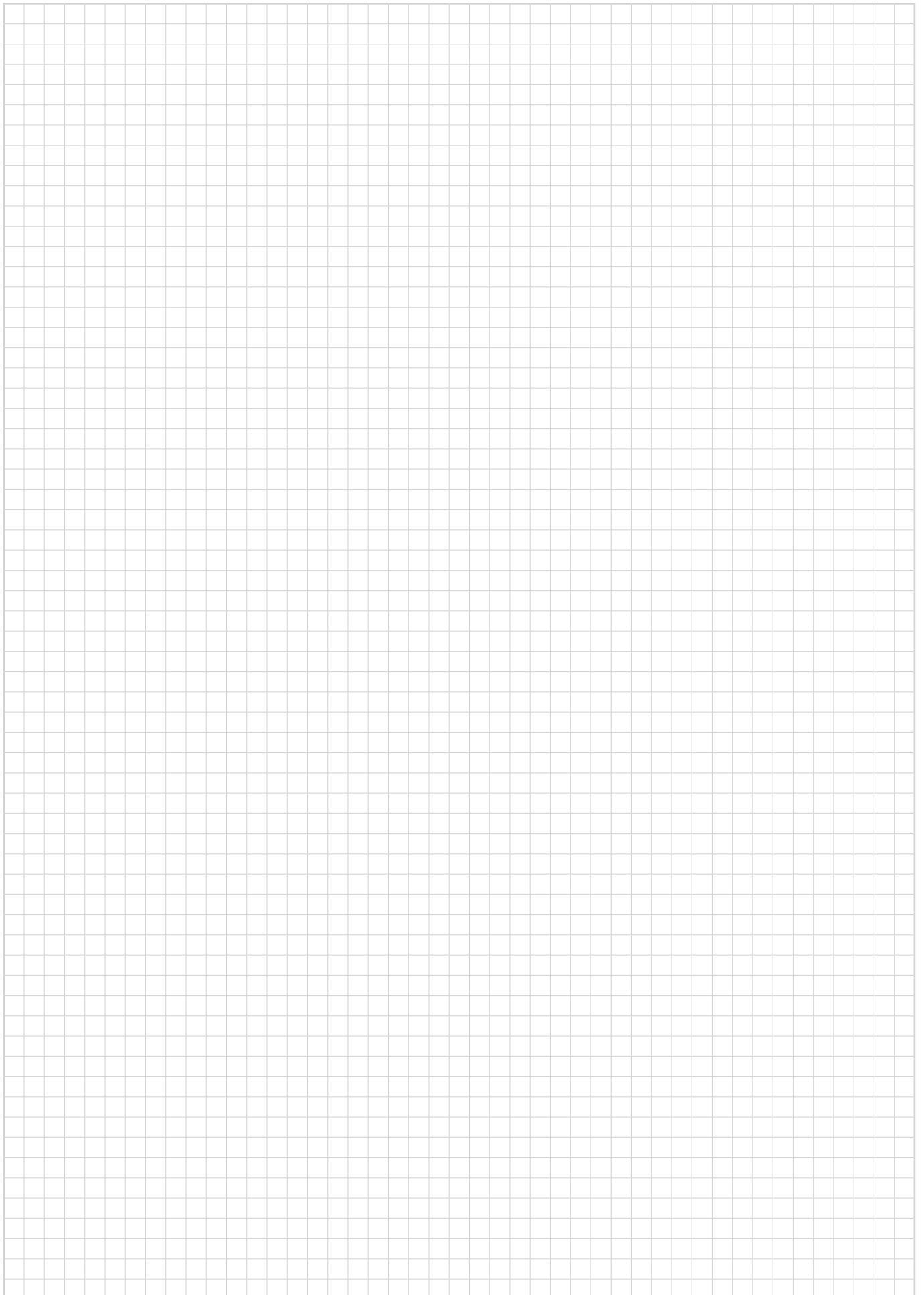



APAC

MGL GLOBAL SOLUTIONS LTD

info.apac@mgl-intl.com
Flat 4-1, 4/F, No. 35, Section 3
Minquan East Road.
Taipei, Taiwan.
Tel: +886 2-2508-0877

EMEA

MGL EUMAN S.L.

info.emea@mgl-intl.com
Parque Empresarial Argame, 33163
Morcín. Asturias, Spain.
Tel: +34 985-08-18-70

AMERICAS

Flat 4-1, 4/F, No. 35, Section 3

US East Coast

2810 Coliseum Centre Drive, Ste. 100.
Charlotte, North Carolina,
28217 USA
Tel: +1 833 533-5899

US West Coast

760 Challenger Street.
Brea, California
92821 USA
Tel: +1 310-728-6220

www.mgl-intl.com

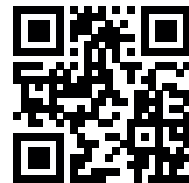

www.clogic-intl.com